

# A MODEL BASED CONTROL CONCEPT WITH KNOWLEDGE BASED OVERHEAD CONTROL OF A ROASTING PROCESS

Bernhard Voglauer, Wolfgang Geyrhofer, Hanns Peter Jörgl  
Institute for Machine and Process Automation  
Vienna University of Technology  
A-1040 Vienna, Austria  
voglauer@impa.tuwien.ac.at

**Abstract**—Steelworks slag is used for the production of vanadium and, therefore, roasted under alkaline conditions in a rotary kiln or multiple hearth furnace. This process is long known but the requirement for more efficient operation makes it difficult for the operator to handle the roaster in an optimal way manually. It is inevitable to hold a given process temperature profile and to provide the correct chemical environment for an efficient mode of operation and to avoid undesirable process states and critical conditions.

This article contains a control concept for a multiple hearth roaster that enables a high degree of automation and is putting much emphasis on industrial applicability. The control concept comprises control loops for temperature control and control of chemical key values, the controller design is mainly based on a previously published dynamic model of the vanadium roast process. Since chemical analysis of the roasted media is considerably time consuming the Smith-Predictor concept is utilized for improved control performance. Furthermore, a knowledge based, supervising fuzzy controller is used to calculate the desired values in order to enhance process efficiency.

**Keywords:** process control, simulation, roasting, modeling, prediction

## I. INTRODUCTION

Vanadium roasting is a well known process for the production of vanadium and can be applied to recover vanadium from steelworks slag [11]. The slag is roasted in a multiple hearth furnace or a rotary kiln under alkaline conditions, usually using  $NaCl$  or/and  $Na_2CO_3$  as additives. Equations 1 to 3 represent the most accepted basic chemical reactions for the conversion of vanadium [1] [2] [4] [6] [7] [8]:

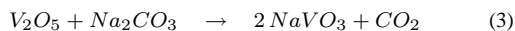
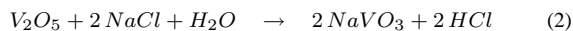
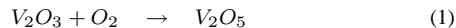

After a residence time of typically 1-2 hours at 750–850 °C most of the mainly trivalent vanadium has reacted to vanadate, which is water-soluble. By subsequent leaching overall recovery gains for vanadium of 60 – 80 % are reported [1][6][7].

The maintenance of an oxidizing atmosphere (see equation 1) during roasting is essential for the conversion of vanadium. Furthermore, accurate temperature control in the roasting units is essential for high vanadium recovery gains and to avoid undesirable process states and conditions like hearth build up [6] [8], which occurs if the liquid phase content exceeds a critical value. Consequently, a well designed control concept is advantageous for high process efficiency.

This paper gives a short description of a previously developed process model of the vanadium roast process. Subsequently, a control concept is proposed and applied to the process. The control performance is then illustrated by simulation results, followed by some concluding remarks.

## II. PROCESS MODEL

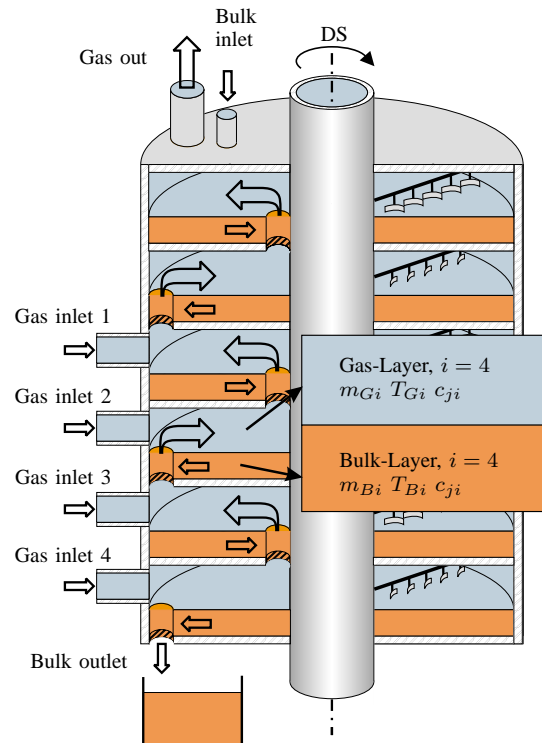

Fig. 1. Scheme of a Multiple Hearth Furnace

Figure 1 shows a scheme of an idealized multiple hearth furnace. For vanadium roasting the slag and some additives like Sodiumchloride and/or Sodiumcarbonate are fed at the top of the furnace and transported from floor to floor by the shaft driven (DS) agitator. Heat and oxygen are provided in some of the floors by burners with a high air excess.

A physically based model of the vanadium roast process in a multiple hearth furnace has been derived earlier [9], assuming homogenous gas- and bulk-layers in every floor. Additionally a new approach for describing the reaction kinetics [10] was used to adequately represent the complex process chemistry. The nonlinear state space model according to equations 4 and 5 is capable of calculating mean values for mass, temperature and concentrations for the  $j$  components on the  $i^{th}$  floor.

$$\dot{\mathbf{x}} = \mathbf{f}(\mathbf{x}, \mathbf{u}) \quad (4)$$

$$\mathbf{y} = \mathbf{g}(\mathbf{x}, \mathbf{u}) \quad (5)$$

Validation of the process model showed good agreement between simulation data and measurement data from a large scale industry plant. The simulation results for the mass flow of the bulk and the temperatures of gas- and bulk-layers showed good consistency [9] and also the much more critical prediction of chemical states proved to be satisfying due to the implementation of the new reaction kinetics approach [10].

Since usually the process is kept within a small operating range it is reasonable to linearize the process model around a typical operating point. With a linear model the design of linear controllers is feasible.

By linearization a state space model according to equations 6 and 7 can be defined

$$\dot{\mathbf{x}} = \mathbf{A}\mathbf{x} + \mathbf{B}\mathbf{u} \quad (6)$$

$$\mathbf{y} = \mathbf{C}\mathbf{x} + \mathbf{D}\mathbf{u} \quad (7)$$

where the matrices  $\mathbf{A}, \mathbf{B}, \mathbf{C}, \mathbf{D}$  represent the jacobian matrices of the nonlinear system (equations 4 und 5) defined by equations 8:

$$\mathbf{A} = \frac{\partial \mathbf{f}}{\partial \mathbf{x}} \quad \mathbf{B} = \frac{\partial \mathbf{f}}{\partial \mathbf{u}} \quad \mathbf{C} = \frac{\partial \mathbf{g}}{\partial \mathbf{x}} \quad \mathbf{D} = \frac{\partial \mathbf{g}}{\partial \mathbf{u}} \quad (8)$$

The stable system (6) and (7) can be verified to be completely state controllable and completely state observable.

For controller design it can be advantageous to convert the state space system to a transfer function system according to equation 9.

$$\mathbf{y} = \mathbf{G} \cdot \mathbf{u} \quad (9)$$

Since the process model order is high due to several decisive states on every floor of the multiple hearth furnace model order reduction is necessary to gain practicable transfer functions. Model order reduction was carried out by assuming a low order transfer function structure according to the global dynamic behavior of the individual transfer

function (e.g.  $3^{rd}$  order with time delay, Equation 10) and subsequent adaption of parameters (here:  $a_0 \dots a_2, b_0$  and  $d$ ).

$$G = \frac{b_0}{s^3 + a_2s^2 + a_1s + a_0} e^{(-s d)} \quad (10)$$

The adaption algorithm is based on the minimization of a quality function  $q = f(a_0 \dots a_2, b_0, d)$  with respect to the parameters  $a_0 \dots a_2, b_0$  and  $d$ , utilizing time and frequency domain simultaneously. The quality function is calculated by the weighted sum of the integrated, squared deviations between the step response  $h(t)$ , the magnitude  $m(\omega)$  and phase  $\varphi(\omega)$  of the original system and the reduced order system according to equation 11.

$$q = \gamma_1 \int \Delta h^2 dt + \gamma_2 \int \Delta m^2 d\omega + \gamma_3 \int \Delta \varphi^2 d\omega \quad (11)$$

Model order minimization worked extraordinarily well by the use of this method.

### III. PROCESS CONTROL

The process model has a MIMO-character of high order and it is important to find and utilize only the decisive inputs and outputs and their assignment. Furthermore, only a few quantities are measurable online or with only small analytical effort offline. Under consideration of these aspects a control concept was designed that seems suitable for industrial control specifications. This section illustrates the control concept and the design procedures of its components.

#### A. Control Concept

Figure 2 shows a block diagram of the controller structure. It consists of three main control loops for

- $pH$ -control: The  $pH$ -value of the roasted bulk is controlled by  $\mathbf{u}_{pH}$ , e.g. the mass flow of Sodiumchloride  $\dot{m}_{NaCl}$  and/or Sodiumcarbonate  $\dot{m}_{Na_2CO_3}$ .
- $c$ -control: Stationary control of a key component concentration by  $\mathbf{u}_c$ .
- $T$ -control: The temperature  $T$  of the the individual floors is controlled by  $\mathbf{u}_T$ , e.g. by gas burners.

The reference values  $w_{pH}$ ,  $w_c$  and  $w_T$  of these control loops are provided by the overhead controller, which utilizes as an input not only the measurements  $\mathbf{y}$  of the controlled variables but also further information about decisive boundary conditions or critical behavior of the process.

#### B. Design of the Temperature Controller

The control requirement of the temperature controller can be described by maintaining a desired temperature profile over the furnace by controlling the temperatures of the individual floors. The first floors are used for preheating and it is not necessary to control the temperature (see figure 1).

A suitable controller design method was proposed by Geyrhofer et.al. [3]. For every single floor a PI-Controller is used to control the temperature, resulting in a strongly coupled

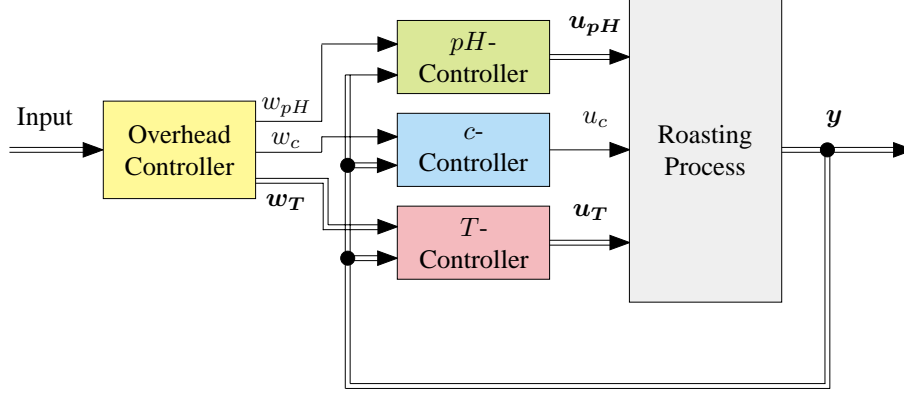

Fig. 2. Block diagram of the controller structure

MIMO system. The controller design itself is based on parameter optimization using the cost function according to equation 12.

$$J = \sum_{i=1}^4 \left( \int_0^t (w_i(\tau) - y_i(\tau))^2 d\tau + \dots \right) \quad (12)$$

$$\dots + \gamma |u_i(t)|_{|u_i(t)| > u_{i,max}} \rightarrow \min_{K_i, T_{n_i}}$$

Here, the sum of the control errors and if the absolute values of control variables  $|u_i|$  are exceeding an upper boundary, weighted control variables are used to calculate the cost function. For a predetermined sequence of step changes of the reference values of the floor temperatures and including the occurrence of major disturbances  $J$  was minimized numerically with respect to all controller gains  $K_i$  and time constants  $T_{n_i}$  of the  $i$  control loops simultaneously. This parameter optimization design resulted in well balanced controllers that also reject the disturbing coupling effects between the different floor temperatures.

Further improvement of the control behavior by decoupling of the temperature control system could not be achieved.

### C. Design of the pH-Controller

A Smith-Predictor appears to be a suitable control concept for pH-control, since the process itself causes a time delay  $T_M$  due to the transportation lag and, even more relevant, offline analysis of the pH-value is considerably time consuming ( $T_A$ ), resulting in a total dead time  $T_{pH}$  according to equation 13.

$$T_{pH} = T_M + T_A \quad (13)$$

With the knowledge of the process model  $G_P$  an estimate  $\hat{pH}$  can be calculated and controlled in advance, while the sampled and delayed value  $pH_{meas.}$  is used to compensate modelling errors or the influence of unaccounted disturbances  $Z_1 \dots Z_m$ . In Figure 3 a block diagram of the pH-control scheme with the Smith-Predictor controller is depicted.

At the end of the roasting process the roasted bulk with a certain pH-value is measured by regular sample taking and

offline analysis. Thus, a delayed, discrete value  $pH_{meas.}$  is available for control purposes. In the design procedure it is assumed, that sample taking is carried out fast enough for sufficient description of the pH-signal resulting in a fast controller. In a second approach the sampling time is assumed to be longer and coarsely quantized with respect to possible practical limitations resulting in a control loop with a higher damping ratio.

Further improvement of the control behavior can be achieved by decoupling of measurable disturbances like slag mass flow  $\dot{m}_S$  and slag vanadium content  $w_{V|S}$  by feed forward control. Since dynamic decoupling is not realizable for these disturbances, stationary decoupling was carried out with the compensator gains defined by equations 14 and 15.  $G_{\dot{m}_S}$  and  $G_{w_{V|S}}$  are the transfer functions between  $\dot{m}_S$  respectively  $w_{V|S}$  and the pH-value.

$$K_{\dot{m}_S} = \lim_{s \rightarrow 0} \left( \frac{G_{\dot{m}_S}}{G_P} \right) \quad (14)$$

$$K_{w_{V|S}} = \lim_{s \rightarrow 0} \left( \frac{G_{w_{V|S}}}{G_P} \right) \quad (15)$$

The design of the controller with the transfer function  $G_C$  was carried out by applying the root locus method on the SISO system with the open loop transfer function  $G_O = G_C \cdot G_P$  considering a fast control behavior with respect to limitations in the control value. A PID-Controller was found to achieve suitable performance.

### D. Design of the c-Controller

The c-control system is of minor importance from the control engineers point of view since in practice the concentration is measured and controlled only in multiples of the system time constant. Nevertheless, it has to be mentioned that this control problem can be solved more than competitively with a well tuned PI controller in comparison to a control algorithm based on a stationary mass balance, as it might be used in practice.

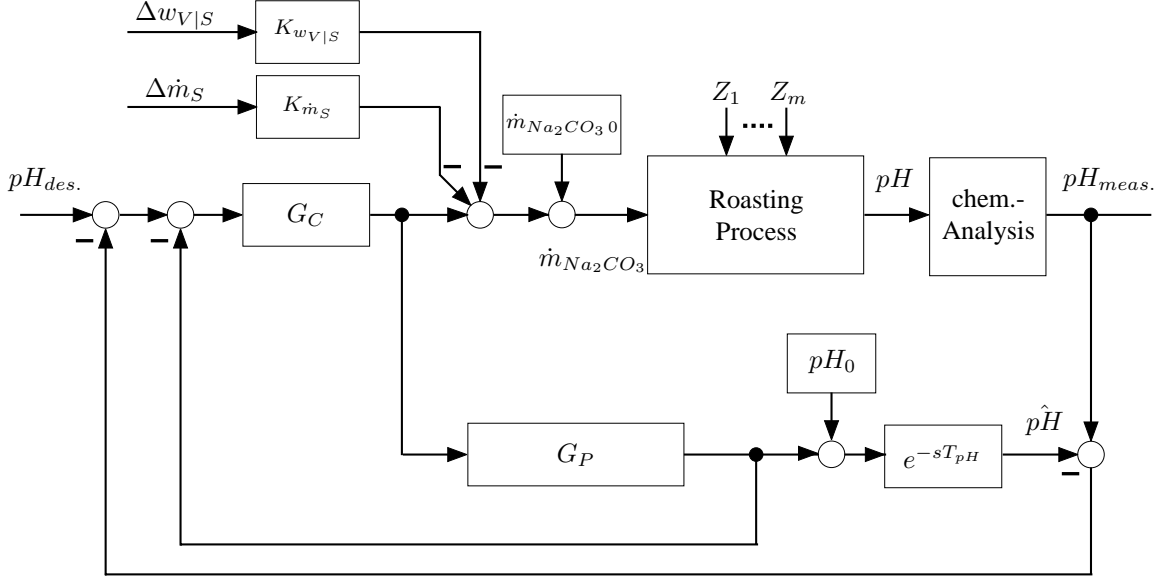

Fig. 3. Block diagram of the  $pH$ -control system with Smith-Predictor and decoupling of major  $pH$ -disturbances

### E. Design of the Overhead Controller

The overhead controller provides reference values for the  $pH$ -controller, the  $c$ -controller and the  $T$ -controller. It acts on the purpose of process efficiency enhancement. Therefore, it has to improve the recovery gain by appropriate adjustment of the controllers and simultaneously avoid undesirable operating conditions, what sometimes results in contradicting demands. Thus, it has to find the optimum between a high recovery gain and good operability. It is very important to accurately detect disadvantageous process behavior and critical quantities, that have to satisfy boundary conditions, e.g. maximum gas temperature at the furnace outlet.

The controller contains three fuzzy systems, that are used for hearth build up detection and calculation of the desired  $pH$  and  $T$ -values. Therefore, simple knowledge based rules were applied to low order (e.g. 2 inputs, 1 output) Mamdani type fuzzy systems.

## IV. RESULTS AND DISCUSSION

### A. $pH$ -Control

Figure 4 shows the simulation result of a step change of the desired  $pH$  value (—). The step response of the fast Smith-Predictor controller (—) follows the desired value with a slight overshoot, the dotted line represents the real  $pH$ -value, while the continuous line shows the sampled and delay measurement  $pH_{meas.}$ , which is available for control. As mentioned above increased sample times of the  $pH$ -value may require higher damping rates (see —) and therefore decreases the advantage of the Smith-Predictor controller against a standard control loop. In case of disturbances, e.g. a step change of the slag mass flow in figure 5, zero position error can be achieved (—), generally. If a disturbance is measurable, decoupling

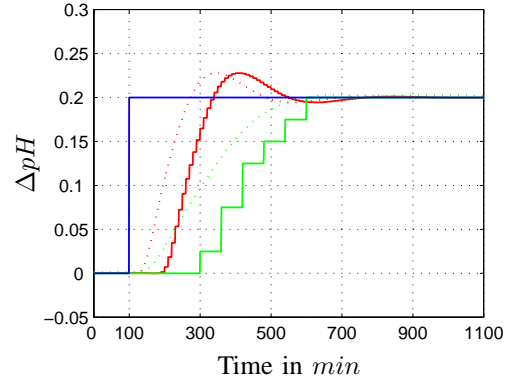

Fig. 4.  $pH$ -deviation after a step change of the reference value (—) at  $t = 100 \text{ min}$  with a fast controller and a slow controller (—  $pH$ ,  $\dots pH_{meas.}$ )

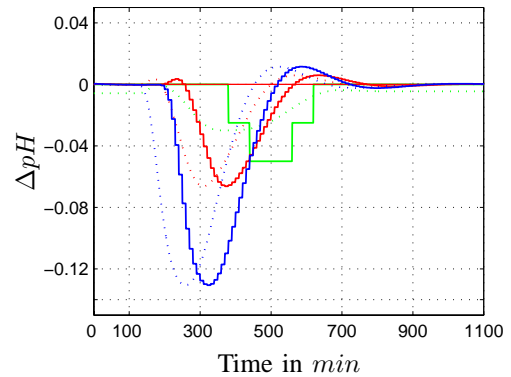

Fig. 5.  $pH$ -deviation after a step change of the slag mass flow at  $t = 100 \text{ min}$  with with a fast controller and a slow controller (—  $pH$ ,  $\dots pH_{meas.}$ )

reduces the deflection significantly, as can be seen in the case of a stepwise change of the slag mass flow with the fast controller (—) and the extraordinarily well performing slower controller (—).

### B. Temperature Control

It is very important that the desired values can be followed accurately to gain the required temperature profile over the roaster. The simulation result in Figure 6 shows the temperature deviations of 4 floors from their operating point values, where the reference value of one floor temperature (—) was increased stepwise by 5 K while the reference values for all other floors remained unchanged. It can be seen that the changing reference value is followed fast (—) and all other temperatures return to their initial values after small deflections.

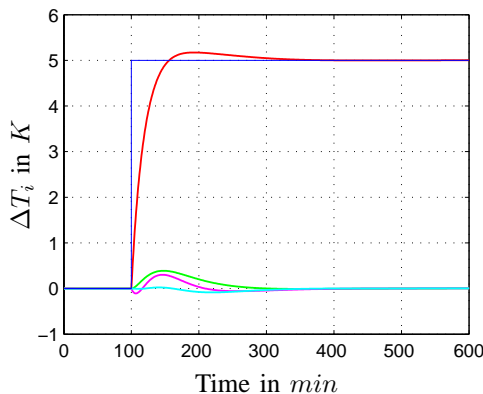

Fig. 6. Temperature deviations  $\Delta T_i$  of the  $i$  floors after a step change of the reference value (—) in one floor (—) at  $t = 100 \text{ min}$

Representative for the ability of sufficient disturbance rejection a simulation result with a stepwise reduction of the slag mass flow is shown in Figure 7. Again excellent control behavior can be found despite a challenging dynamic behavior of the process in this case. Of course, satisfying control behavior is subject to sufficient capacity of the gas burners. Practically, it is of great importance to introduce the heat flow without producing hot spots in the bulk followed by inadmissible melting.

### C. Overhead Control

The overhead controller tries to improve the recovery gain ( $RG$ ) mainly by appropriate adjustment of the desired values of temperatures  $T_i$  of the  $i$  floors and the  $pH$ -value. From figures 8 to 10 it can be seen, that in the simulated situation this can be achieved by increasing both, temperatures and  $pH$ -value. If no major impacts by the chosen mode of plant operation occur during a day,  $T$  and/or  $pH$  are increased until acceptable recovery gains are obtained.

In case of inadmissible disturbances the desired values are altered immediately. After every day, the overhead controller analyzes the previous day for the occurrence of disturbances, and if too many have occurred due to a critical

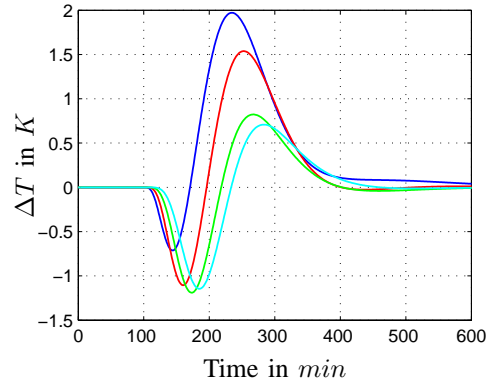

Fig. 7. Temperature deviations after a stepwise reduction of the slag mass flow at  $t = 100 \text{ min}$

mode of operation a reduction of  $T$  and/or  $pH$  is carried out.

Since the operation of the three basic controllers for  $T$ ,  $pH$  and  $c$  has not yet been tested practically, the knowledge base for the overhead controller is rather weak and could be definitely improved.

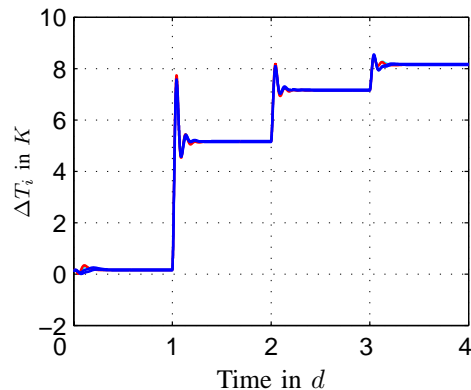

Fig. 8. Temperature deviations  $\Delta T_i$  of the  $i$  floors for undisturbed operation

## V. CONCLUSION

Concluding this work it should be emphasized that a control concept for a multiple hearth furnace was successfully realized and tested in simulation with a previously developed process model. The control concept was developed with much emphasis on robustness and therefore, it seems well suited for industrial application, although essential validation still has to be carried out. Concerning applicability it is always important to consider achievable online measurement accuracy or measurability in general with a sufficiently high sampling rate. Usually, measurement of chemical quantities in the case of heterogenous reactions have to be done offline. This might be a restriction for  $pH$ -value control and constitutes an obstacle for eventually more sophisticated and effective types of controllers.

## ACKNOWLEDGMENT

This project was supported within the scope of the Industrial Competence Center for Mechatronics and Automation

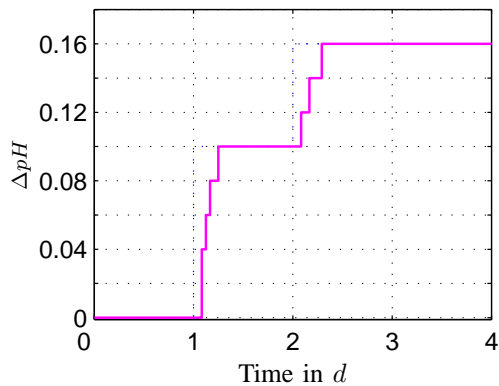

Fig. 9.  $pH$ -deviation for undisturbed operation, —  $pH_{meas.}$ , ··· reference value

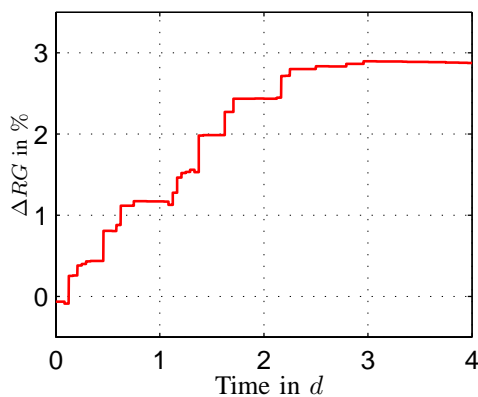

Fig. 10. Increase of the recovery gain (RG) in case of undisturbed operation

(IKMA) by the Austrian Ministry for Economic Affairs (BMWA) and the Provincial Government of Upper-Austria. The authors would like to thank VOEST-ALPINE MECHATRONICS GmbH. and all other cooperating industry partners and supporting institutions.

#### REFERENCES

- [1] W.H. Drescher, *A mechanism study of the formation of sodium vanadate compounds under the conditions of the salt-roast process*, In: Proceedings of the annual meeting of the Society of Mining Engineers of AIME, St. Louis, U.S.A., 1961.
- [2] G. Gabra, I. Malinsky, *A comparative study of the extraction of vanadium from titaniferous magnetite and slag*, In: Proc. of 110th AIME Meeting, Chicago, U.S.A., pp. 167-189, 1981.
- [3] W. Geyrhofer, B. Voglauer, H.P. Jörgl, *Control of a roasting process for the recovery of vanadium*, In: Proceedings of Conference of Control Applications 2003 (CCA 2003), Istanbul, Turkey, pp. 614-617, 2003.
- [4] J.B. Goddard, J.S. Fox, *Salt roasting of vanadium ores*, In: Proc. of 110th AIME Meeting., Chicago, U.S.A., pp. 127-145, 1981.
- [5] N.N. Greenwood, A. Earnshaw, *Chemie der Elemente*, 1st ed., VCH, 1990.
- [6] E. Hukkanen, H. Walden *The production of vanadium and steel from Titanomagnetites*, International Journal of Mineral Processing, 15, pp. 89-102, 1985.
- [7] P. Kanta Rao, P.V.R. Bhaskara Sarma, A.K. Tripathy, P.K. Jena, *Extraction of vanadium as high-purity vanadium pentoxide from vanadium-bearing titaniferous magnetites*, Transactions - Institute of Mining and Metallurgy Mining, Section C, 88, pp. 187-190., 1979.
- [8] B. Rohrmann, *Vanadium in South Africa*, Journal of the South African Institute of Mining and Metallurgy, 85, pp. 141-150, 1985.
- [9] B. Voglauer, H.P. Jörgl, *Dynamic model of a rotary kiln for process simulation and control*, In: Proceedings of 4th MATHMOD, Vienna, Austria, pp. 1051-1056, 2003.
- [10] B. Voglauer, A. Grausam, H.P. Jörgl, *Reaction kinetics of the vanadium roast process using steel slag as a secondary raw material*, In: Proceedings of Processing and Disposal of Mineral Industry Wastes 03 (PDMIW'03), Falmouth, U.K., 2003.
- [11] K. Winnacker, L. Küchler, *Chemische Technologie-Band 4 (Metalle)*, 4th ed., Carl Hanser Verlag, 1986.