

BI-DIRECTIONAL ENERGY INTERFACES FOR MIXED REALITY DESIGN – VIRTUAL EQUIVALENCE –

Yong-Ho Yoo, Wilhelm Bruns

Bremen University, Germany
Research Center for Work, Environment and Technology (artecLab)
yoo@artec.uni-bremen.de
bruns@artec.uni-bremen.de

Abstract: *Virtual Equivalence*, a concept to implement bi-directional energy-based interfaces between real and virtual models, will be introduced. It consists of two steps: 1. replacement of a complex virtual circuit by a simplified equivalence and 2. connecting this simplified equivalence to a bi-directional power interface allowing interactions between the real and virtual circuits. An arbitrary circuit in the virtual environment can be substituted by a simplified uniform circuit which then can be physically implemented and connected to the real circuit in the real environment. The concept of continuous electric power flow (current \times voltage), its theoretical foundation and its implementation as bi-directional mixed reality port are presented. Copyright © 2005 IFAC

Keywords: Computer interface, Mixed Reality, Energy transfers

1. INTRODUCTION

Most computer interfaces, Fig. 1, use one-way links between the computer and the real environment to process and display input signals from the real environment, or transmit feedback signals from the computer to the real environment, and it is a one-way signal flow at a low power level (current \times voltage) (Karnopp, 1990). However, in many cases of real electric circuit design, the power is of bi-directional nature and is not restricted to a signal level. To implement a true power interaction between the virtual component within the computer and a real component in the environment, the same physical laws have to be applied on both sides of the interface without preference of one energy flow direction. Separating signal level phenomena inside the computer from energy phenomena outside the computer by D/A and A/D converters and amplifiers has the advantage of generality and strict semantic separation, however the disadvantage of distinct implementation requirements and conceptual understanding for/of every special application.

Handling signal and information flows on the computer side in accordance to and continuation of external energy flows has some advantages for a certain class of applications, namely the consistent modeling and simulation of component based connection oriented physical systems. The more we aim at an open merge of virtual and real components of an overall functional system, the more we need interfaces merging the semantic levels of signal/control and energy flows. A new computer interface as shown in Fig. 2, using true power interactions, applying the same physical law as in the real electric circuit, would open up new possibilities.

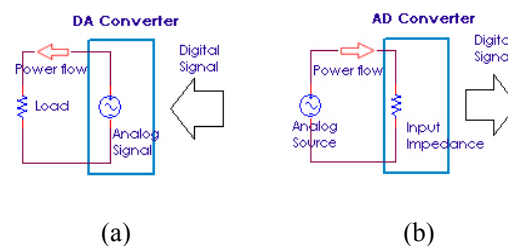

Fig. 1. General computer interfaces.

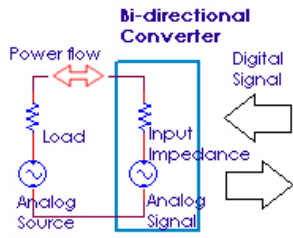

Fig. 2. Bi-directional computer interface

Bruns (2003) introduced the concept of Hyper-Bonds, bi-directional links between the virtual and the real parts of a connection oriented model, being able to sense and generate various relevant physical continuous effort and flow phenomena via universal connections. This concept is supported by the Theory of Bond Graphs (Karnopp, 1990 & Ohta, 1999). Bond-Graph theory considers a continuity of energy (Effort \times Flow) flow in abstract networks. Effort can be electric voltage, air pressure, force, momentum, temperature, etc. Flow can be electric currency, air volume flow, velocity, heat-flow etc. Some applications of the Hyper-Bond concept have been demonstrated, e.g. mixed reality environments for electro-pneumatic¹ (Fig. 3) and force feedback (Yoo & Bruns, 2004) (Fig. 4).

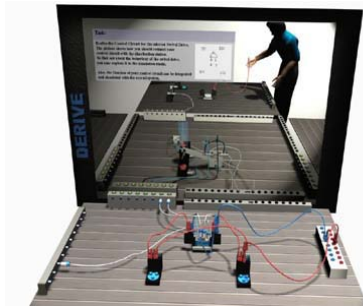

Fig. 3. DERIVE Learning Environment

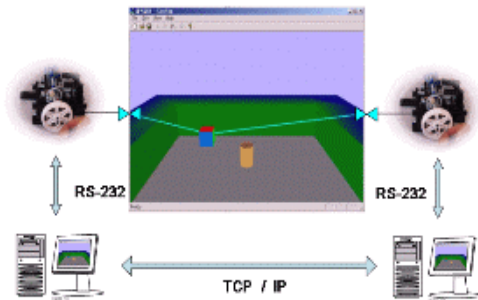

Fig. 4. Distributed Mixed Reality Model

In order to simplify a virtual circuit and bi-directionally connect it with a real circuit, a virtual circuit in the virtual environment is replaced by an equivalent circuit led by the Thevenin's and Norton's Theorems, and physically implemented

¹ EU-IST Project DERIVE (Distributed Real and Virtual Learning Environment for Mechatronics and Tele-Service)

and connected with the real circuit in the real environment. Mixing real and virtual parts of a system may be very helpful for the design of an overall behavior if the user wants to include components of which there is no complete formal model available, but which still show an observable behavior in a connection.

2. THEVENIN'S AND NORTON'S THEOREMS

In order to analyze an electric network, the Thevenin's and Norton's theorems are often used and well-known in the circuit analysis field. These are extremely useful circuit analysis theorems which can be used to replace the entire network, exclusive of the load, by an equivalent circuit that contains only an independent voltage source in series with a resistor in such a way that the current-voltage relationship at the load is unchanged. Assuming that Fig. 5 is a complex network split into two parts, from which the circuit A must be linear and the circuit B may be linear or nonlinear, the fact that the left of Fig. 6 is equivalent at terminals A-B to circuit A in Fig. 5 is a statement of Thevenin's theorem, and the fact that the right of Fig. 6 is equivalent at terminals A-B to circuit A in Fig. 5 is a statement of Norton's theorem. Both theorems are complementarily used to analyze an electric network.

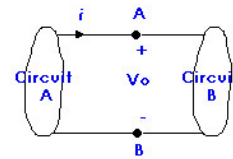

Fig. 5. A complex network split into two parts.

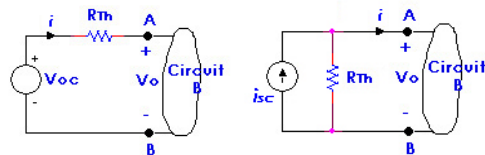

Fig. 6. Thevenin and Norton equivalent circuits.

In Fig. 6, R_{Th} is the equivalent resistance looking back into circuit A from terminals A-B with all independent sources made zero in circuit A, V_{oc} is the open-circuit voltage of the condition when i is zero, and i_{sc} is the short-circuit current due to all sources in circuit A with V_o replaced by a short circuit. The equations are as follows,

$$V_o = V_{oc} - R_{Th} \cdot i \quad (1)$$

$$i = i_{sc} - \frac{V_o}{R_{Th}} \quad (2)$$

In Fig. 7, an example of the Thevenin's and Norton's equivalent theorem is shown for a resistor network

where resistors and independent sources exist. Fig. 7a shows a complex circuit; its equivalent circuit is represented in Fig. 7d. From Eq. (1) and the condition $i = 0$ (Fig. 7b), it follows $V_{oc} = V_o$. Thus, V_{oc} is calculated from equations (3).

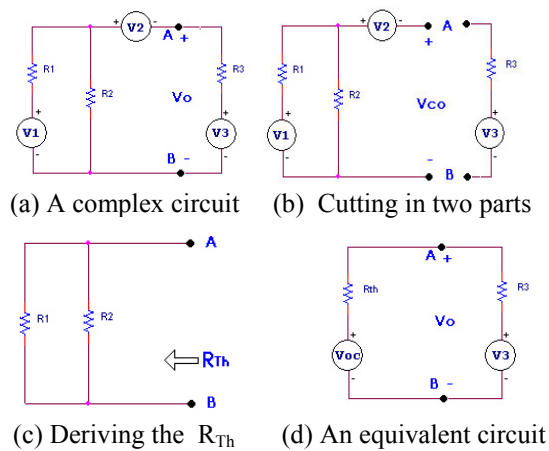

Fig. 7. An example of the Thevenin's and Norton's equivalent theorems

R_{Th} is derived from Fig. 7c. Thus, the equations are as follows,

$$V_{oc} = \frac{R_2}{R_1 + R_2} \cdot V_1 - V_2 \quad (3)$$

$$R_{Th} = \frac{R_1 \cdot R_2}{R_1 + R_2} \quad (4)$$

3. VIRTUAL EQUIVALENCE

Virtual Equivalence is to replace an arbitrary virtual circuit by a simplified circuit, connected with a real circuit (Fig. 8). In the right circuit of Fig. 8, it is possible to use a digital potentiometer, which can be controlled by the computer, to implement the equivalent resistance, R_{Th} . Therefore, an arbitrary virtual circuit can be replaced by a digital potentiometer and a D/A output port which output the signal (V_{oc}) calculated by the computer.

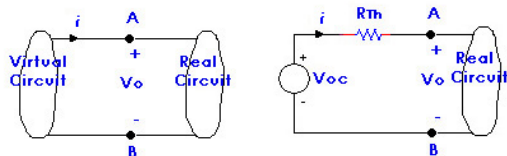

Fig. 8. Convert the virtual circuit to a virtual equivalent circuit

A hardware construction to actually implement 2-Port Virtual Equivalence is shown from Fig. 9. In this construction, the V_{oc} signal is transmitted from the PC to a V_{oc} port using a D/A converter, and a digital potentiometer controlled by a computer has the same resistor value as R_{Th} . Because it is not

advisable to directly connect a D/A converter to a power consuming real circuit and it is more secure to separate D/A converter and real circuit, an OPAMP, as a voltage follower, is connected between the V_{oc} and the R_{Th} .

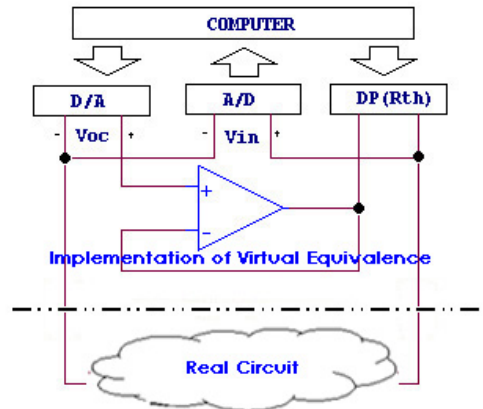

Fig. 9. 2-Port Virtual Equivalence

4. MIXED REALITY BREADBOARD

As a simple application to demonstrate the Virtual Equivalence concept, a Mixed Reality Breadboard supporting a real extension of an electric circuit simulator program OrCAD—a commercial program which can edit and simulate various electric circuits—is presented (Fig. 10). While running this application, an arbitrary virtual circuit designed by OrCAD schematic editor has a true power connection, such as in Fig. 2, with a real circuit via the bi-directional mixed reality port.

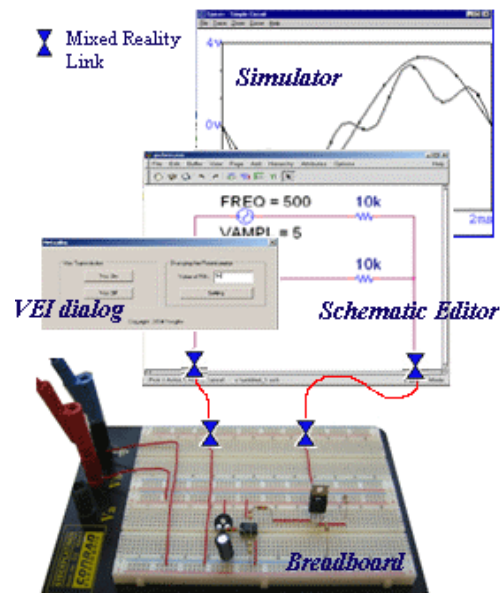

Fig. 10. Framework of Mixed Reality Breadboard

A Mixed Reality Breadboard consists of a real breadboard, OrCAD schematic editor and simulator and a VEI (Virtual Equivalence Interface) module. Using OrCAD schematic editor, users can design a

virtual circuit with some virtual components (resistors, transistors, diodes etc, except for capacitors and inductors) and connect it with the real components (resistors, transistors, capacitors, inductors etc) via the Virtual Equivalence Interface module.

In Fig. 11 and Fig. 12, implementations of VEI module are shown. In Fig. 11, DP (R_{Th}) is a digital potentiometer (DS1267 chip made by DALLAS) controlled by a programmable logic controller (C-Control Station made by Conrad Electronic) connected with the main computer via the serial interface. DS1267 provides two channels of each controlling a variable resistor with a resolution of 8 bits. The device performs the same electronic adjustment function as a potentiometer or variable resistor.

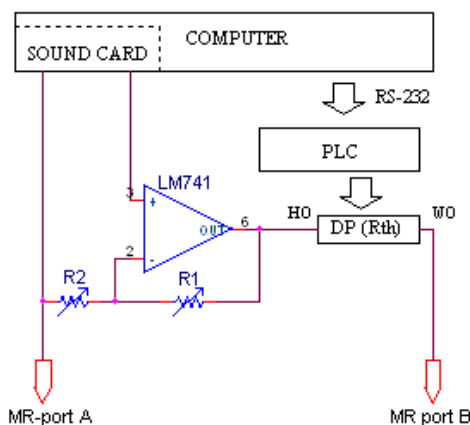

Fig. 11. VEI hardware module

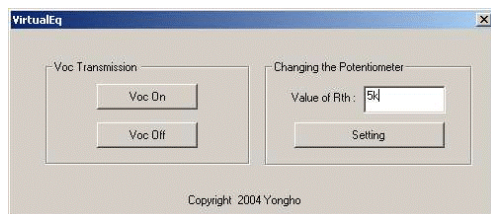

Fig. 12. VEI dialog window

Users can easily calculate the R_{th} of an arbitrary virtual circuit using OrCAD simulator (see OrCAD Pspice for Windows Volume 1). In our prototype implementation, we calculated R_{th} for a given virtual circuit by using OrCAD and then manually input it into our VEI (Fig. 12). This of course can be integrated into the VEI and automated for any circuit later. Before running the VEI dialog window, the V_{oc} signal of an given virtual circuit should be simulated using OrCAD simulator in order to produce a CSDF (Common Simulation Data Format) file, from which the V_{oc} signal transmitting to the real circuit is derived. A PC-soundcard is used as a D/A converter. Though it is available only in the frequency bandwidth for voice, its advantages are simple, low-cost and popular. The VEI program converts a CSDF file to wave form signals and

transmits it to a PC-soundcard. The output of the PC-soundcard is connected to a non-inverting amplifier with an op amplifier. V_{oc} is calculated from Eq. (5).

$$V_{oc} = \left(1 + \frac{R_1}{R_2}\right) \cdot V_{sound} \quad (5)$$

5. EXPERIMENTS

A mixed reality circuit (Fig. 13) is used in two ways to demonstrate the difference between a general computer interface and the Virtual Equivalence interface. In first case, the virtual circuit in Fig. 13 is connected with the real circuit via a general interface: signals between port A and port B from the virtual circuit are directly transmitted to the real circuit, such as in Fig. 1a. In the second, the virtual circuit is connected with the real circuit via the VEI module in the Mixed Reality Breadboard (Fig. 10).

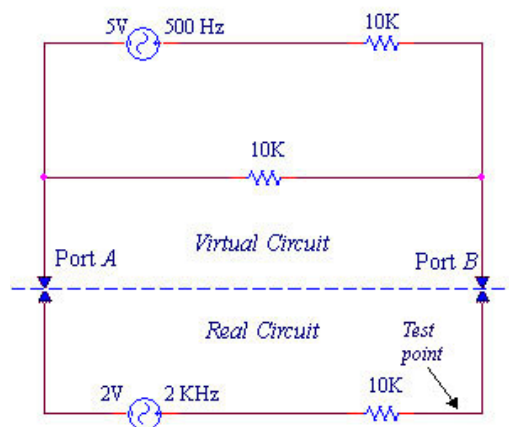

Fig. 13. A mixed reality circuit

In both cases, the voltage and the current of the test point in Fig. 13 are measured as shown in Fig. 14 and Fig. 15. Curve II shows an approximate shape to the theoretical power expected at the test point. However, curve I shows a significant different from the expected behavior.

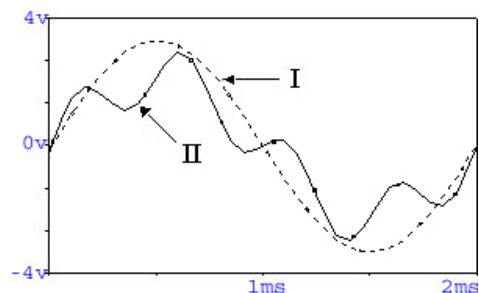

Fig. 14. Voltage comparison of a general interface (I) and the Virtual Equivalence interface (II)

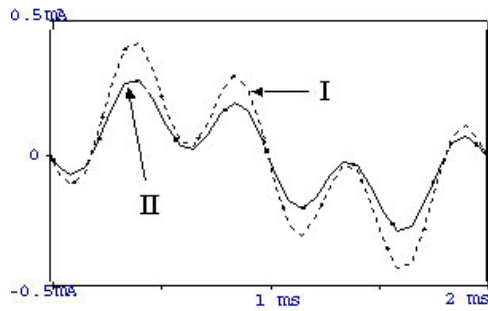

Fig. 15. Current comparison of a general interface (I) and the Virtual Equivalence interface (II)

6. PERSPECTIVES

The presented solution can be useful in on-line education based on remote and distributed laboratory equipment. But it also may prove to be of considerable advantage for systems design, where the design is based on a mixture of components fully specified in adequate formal representations and components of complex, not completely known structure. Furthermore, the concept allows a free distribution of a system over dislocated places of real components. Using the theory of bond-graphs allows the mapping of electrical circuits to any other system characterized by effort/flow phenomena. Therefore the presented considerations can be easily transferred to mechanical, thermodynamic, hydraulic or pneumatic systems.

REFERENCES

- Bruns, F. W. : Hyper-Bonds (Enabling Mixed Reality) , artec-paper 82, Bremen, 2003
- Don H. Johnson : Origins of the Equivalent Circuit Concept, Rice University, MS366, Houston, TX77251
- Jan, F. Broenick (1999): Introduction to Physical Systems Modelling with Bond Graphs – University of Twente, Netherlands
- Karnopp, D. C., D.L. Margolis, R.C. Rosenberg : System Dynamics – A unified Approach, John Wiley, New York, 1990
- Roy, Goody: OrCAD Pspice for Windows Volume 1:DC and AC Circuits 3rd Edition – Prentice Hall, 2000
- Ohta, Y., H. Tamura (1999). Mixed Reality – Merging Real and Virtual Worlds. Tokyo
- Yoo, Y., : Mixed Reality Electric Circuit, artec-paper 114, Bremen, 2004
- Yoo, Y., Bruns, F. W. (2004). Realtime Collaborative Mixed Reality Environment with Force Feedback. Proc. 7th IFAC Symposium on Cost Oriented Automation, Ottawa
- Yoo, Y., Bruns, W. (2004). Motor Skill Learning with Force Feedback in mixed Reality. 9th IFAC Symp. on Analysis, Design, and Evaluation of Human-Machine Systems, Atlanta