

MANAGING PERFORMANCE DEGRADATION IN FAULT TOLERANT CONTROL SYSTEMS

Youmin Zhang[†], Jin Jiang[‡], Zhenyu Yang[†], Akbar Hussain[†]

[†]*Dept. of Computer Science and Engineering, Aalborg University Esbjerg, Niels Bohrs Vej 8, 6700 Esbjerg, Denmark*

[‡]*Dept. of Electrical and Computer Engineering, The University of Western Ontario, London, Ontario, N6A 5B9, Canada*

Abstract: A fault tolerant control system design technique has been proposed and analyzed for managing performance degradation in the presence of multiple faults in actuators. The method is based on a control structure with model reference reconfigurable control design in an inner loop and command input adjustment in an outer loop. The reduced dynamic performance requirements in the presence of different actuator faults are accounted for through different performance reduced (degraded) reference models. The degraded steady-state performance are governed by the reduced levels of command inputs. The reconfigurable controller is designed on-line and automatically in an explicit model reference control framework so that the dynamics of the closed-loop system follows that of the performance reduced reference model under each fault condition. The reduced command input level is determined to prevent potential actuator saturation. The proposed method has been evaluated and analyzed using an aircraft example against actuator faults subject to constraints on the magnitude and slew-rate of actuators. *Copyright ©2005 IFAC*

Keywords: Fault tolerant control system (FTCS), multiple actuator faults, performance degradation, model reference reconfigurable control, command input adjustment.

1. INTRODUCTION

In view of potential performance limits induced by physical limitations (such as actuator magnitude and slew-rate saturation) in practical control systems, research on performance limitation and degradation in control system design has began to attract considerable attention recently (Chen and Middleton, 2003; Goodwin *et al.*, 2001; Perez *et al.*, 2003; Zhang and Jiang, 2003b). Even though fault tolerant control of safety-critical systems is an active research topic currently and significant amount of research has been done in this area in the last two decades (Blanke *et al.*, 2003; Mahmoud *et al.*, 2003; Patton, 1997; Zhang and Jiang, 2003a), the FTCS design which considers the fault-inflicted physical constraints for maintaining achievable performance has mostly been ignored until recently (Zhang and Jiang, 2003b). In this recent work, two reference models are used one for the normal system operation and the other for the system under contingencies with actuator failures, respectively. Although a very important concept has been presented therein, it soon becomes evident that a twin model approach is not comprehensive enough to capture all potential system malfunctions. Different actuator faults in a system can exhibit distinctive characteristics; they cannot and should not be modeled only by a single performance reduced model. One of the objectives of this

paper is to extend the previous work by incorporating different performance reduced reference models for achieving graceful performance degradation in the presence of different actuator faults. Such graceful performance degradation is defined as the ability of a fault tolerant control system (FTCS), in the event of a fault, to automatically reduce its demand on a specific level of performance so that the primary control objectives can be achieved under the constraints of the available redundancy and control capability. Design of such a FTCS can be achieved by the design of multiple performance reduced reference models and the associated fault tolerant controllers, as well as the selection of different levels of command inputs associated with each fault conditions.

By representing each actuator fault via a performance reduced reference model which is synthesized with consideration of system performance limitations under the fault condition, the overall fault handling capability of a control system can be enhanced considerably. Since a unity steady-state gain of each reference model is required for the purpose of command tracking, the degradation levels in dynamic performance in the presence of faults are mainly governed by specified performance degraded reference models. Therefore, adjustment to the system command input levels is also crucial in achieving gracefully degraded performance in the event of system component failures. Furthermore, a dynamic adjustment strategy based on the con-

cept of pre-filter has been examined to provide a way for dynamic adjustment of command inputs during the initial period of controller reconfiguration. Relationship between the pre-filter technique and the command governor scheme developed in Zhang and Jiang (2003b) is also examined.

The paper is organized as follows: The overall control structure for achieving graceful performance degradation under multiple actuator faults is presented in Section 2. Role of reference models and schemes for selecting a set of performance reduced reference models is presented in Section 3. A strategy for dynamic adjustment of the command inputs is presented in Section 4. A model reference reconfigurable control design scheme associated with corresponding degraded reference model is given in Section 5. Performance evaluation of the designed FTCS for an aircraft example is presented in Section 6 followed by the conclusion in Section 7.

2. THE OVERALL FTCS STRUCTURE

The overall structure of the proposed FTCS is depicted in Fig. 1, which includes modules of multiple reference models, fault detection and diagnosis (FDD), reconfiguration mechanism, and model reference reconfigurable controller in the inner loop, and the command adjustment module in the outer loop. For achieving gracefully degraded performance while keeping minimum complexity of the developed FTCS, one performance degraded reference model is used with respect to (w.r.t.) each actuator with different levels of fault severity.

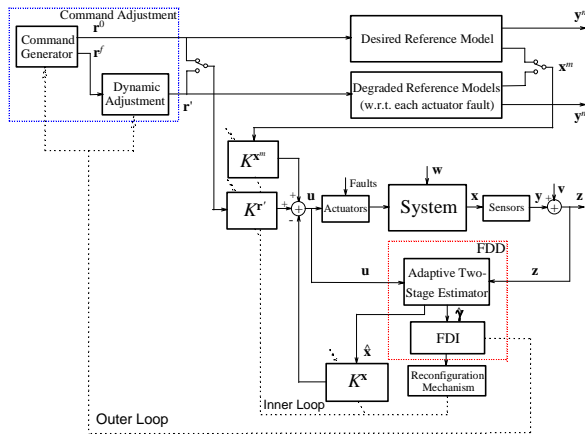

Fig. 1. Overall structure of the proposed FTCS

The structure of inner-outer loop makes us to be able to achieve specified performance degradation for system at both transient and steady-state periods, with the purpose to avoid potential magnitude and slew-rate saturation of the actuators. The inner loop is also responsible to guarantee the stability and to achieve desired dynamic performance through a reconfigurable model reference control strategy. The main function of the outer loop is to re-adjust the command input levels such that

potential saturation in the steady-state of the reconfigured system as well as the transient interval during controller reconfiguration can be avoided.

To implement the above fault tolerant control design in real-time, the post-fault system model has to be determined on-line and the state variables must be available for feedback. In practice, only part of the state variables may be measurable. To provide required state and fault parameters for feedback, simultaneous state and parameter estimation techniques need to be used as shown in Fig. 1. A two-stage adaptive Kalman filter (TSAKF) (Zhang and Jiang, 2002) has been used for such purpose. Furthermore, the fault detection and isolation (FDI) scheme and the reconfiguration mechanism are also needed. The details on a TSAKF-based fault detection and diagnosis (FDD) scheme outlined in Fig. 1 have been omitted herein. Interested reader can refer to Zhang and Jiang (2002) for details. In the following sections, modules relating to multiple performance reduced reference models, command adjustment, and reconfigurable model reference controller will be described.

3. DESIGN OF MULTIPLE PERFORMANCE REDUCED REFERENCE MODELS

3.1 Role of Performance Reduced Reference Models

As can be seen from Fig. 1, reference models play an important role in achieving specified/degraded performance under normal and fault conditions. In particular, the dynamic behavior of the post-fault system is governed by the dynamics of designed reference model. The reference models also affect the magnitude and slew-rate of generated closed-loop control signals through feedback-loop. Therefore, appropriate selection of degraded reference models is important to achieve specified but degraded performance. If the reference model is selected so that the outputs of the reference model follow the desired outputs, very quickly. Usually, a large overshoot and a short rise time may occur and the corresponding control signals needed to track the responses of the reference model may become large in both slew-rate and magnitude, which may reach or exceed the actuator slew-rate or magnitude saturation region. However, if the reference model is selected so that the outputs track the command inputs rather slowly, then the tracking accuracy improves without showing overshoots or going into actuator saturation region, but the responses may become sluggish. Therefore, for the purpose to achieve specified performance with degraded level in the event of a system component failure, it is preferable to design appropriate reference models which takes a good trade-off between the achievable performance and the physical constraints of the system.

3.2 Performance Reduced Reference Models Design

Assume that a reference model of the system under the normal condition is represented by:

$$\begin{aligned}\dot{\mathbf{x}}_0^m &= A_0^m \mathbf{x}_0^m + B_0^m \mathbf{r}'_0 \\ \mathbf{y}_0^m &= C_0^m \mathbf{x}_0^m\end{aligned}\quad (1)$$

where $\mathbf{x}_0^m \in \mathfrak{R}^n$ is the state vector of the reference model; $\mathbf{y}_0^m \in \mathfrak{R}^p$ is the output vector; and $\mathbf{r}'_0 \in \mathfrak{R}^l$ is the command input vector. It is assumed that $p = l$ for the purpose of command tracking. The above model, known as the *desired* reference model, specifies the desired dynamic characteristics of the system under the normal condition.

In the presence of a fault, it is expected that the system eigenvalues of the performance reduced reference models would shift towards the imaginary axis to reflect the loss of system dynamic performance. Based on this fact, a design scheme has been proposed in Zhang and Jiang (2003b). Such scheme can be tailored to the multiple faults case. Hence, a set of performance reduced (degraded) reference models can be determined based on the desired reference model by:

$$\begin{aligned}\dot{\mathbf{x}}_j^m &= A_j^m \mathbf{x}_j^m + B_j^m \mathbf{r}'_j \\ \mathbf{y}_j^m &= C_j^m \mathbf{x}_j^m\end{aligned}\quad j = 1, \dots, l \quad (2)$$

where $A_j^m = \Psi_j^{-1} A_0^m$, $B_j^m = \Psi_j^{-1} B_0^m$, $C_j^m = C_0^m$, $\forall j = 1, \dots, l$.

The above scheme is solely based on placing eigenvalues for the selection of performance reduced reference models. In view of the advantages of eigenstructure (both eigenvalues and eigenvectors) assignment, a better scheme can be developed based on eigenstructure assignment since it allows designers to directly satisfy specifications in terms of transient response through selection of reference eigenvectors. However, selection of appropriate eigenstructures in the presence of different faults involves more design effort and need certain engineering insight and experience.

4. COMMAND INPUT ADJUSTMENT

To ensure that all of the system variables are within the safe region and that all of the control actuators are free from saturation for reconfigured system, one has to make appropriate adjustments to the level of required control command inputs as well.

Generally speaking, adjustment of command input should include two parts: 1) selection of a set of new command inputs to the system at the steady-state with respect to different fault conditions; 2) dynamic adjustment of the command inputs during the initial period of control reconfiguration. The first part is to set acceptable new steady-state operating conditions which minimizes the performance degradation while simultaneously avoid potential actuator magnitude saturation at steady-state. The role of the second part is to reduce the

possibility of actuator slew-rate as well as magnitude saturation during the transient interval of control reconfiguration process.

For selection of a set of new command inputs at the steady-state, a similar scheme as in Zhang and Jiang (2003b) is tailored to the current multiple actuator faults case. As an alternative, however, a pre-filter scheme is examined for dynamic adjustment of the command inputs. This can be described as follows.

Assume that a fault is detected at the time instant k_D , then the following modified command input $\mathbf{r}'(k)$ will be generated based on the new command input $\mathbf{r}'_j^f, j \in \{1, \dots, l\}; \forall k \geq k_D$, as

$$\mathbf{r}'(k) = (1 - \rho) \cdot \mathbf{r}'(k - 1) + \rho \cdot \mathbf{r}'_j^f, \quad j \in \{1, \dots, l\} \quad (3)$$

where ρ ($0 \leq \rho \leq 1$) is a weighting parameter governing the decay rate of switching and the initial value of $\mathbf{r}'(k - 1) = \mathbf{r}^0, \forall k < k_D$. Ideally, $\mathbf{r}'(k) = \mathbf{r}'(k - 1) = \mathbf{r}^0$ if $\rho = 0$, and $\mathbf{r}'(k) = \mathbf{r}'_j^f, j \in \{1, \dots, l\}$ when $\rho = 1$. The smaller the ρ is, the slower the decay rate of the switching is. As k increases, $\mathbf{r}'(k)$ will approach to $\mathbf{r}'_j^f, j \in \{1, \dots, l\}$.

It is interested to note that the scheme in Zhang and Jiang (2003b) would be equivalent to the above pre-filter scheme if fixed weighting parameters had been used. The advantage of the above pre-filter scheme is that only one parameter needs to be determined to achieve smooth command switching.

5. DESIGN OF MODEL REFERENCE RECONFIGURABLE CONTROLLER

To illustrate the reconfigurable control design process, the system model under both normal and various actuator fault conditions can be written as:

$$\begin{aligned}\mathbf{x}(k + 1) &= F\mathbf{x}(k) + G_j \mathbf{u}(k) + \mathbf{w}(k) \\ \mathbf{y}(k) &= H\mathbf{x}(k), \quad j = 0, \dots, l \\ \mathbf{z}(k) &= H\mathbf{x}(k) + \mathbf{v}(k)\end{aligned}\quad (4)$$

where $\mathbf{x} \in \mathfrak{R}^n$ is the state vector; $\mathbf{z} \in \mathfrak{R}^m$ the measurement vector; $\mathbf{u} \in \mathfrak{R}^l$ the control input vector; $\mathbf{y} \in \mathfrak{R}^p$ the controlled system output vector, and $\mathbf{w} \in \mathfrak{R}^n$ and $\mathbf{v} \in \mathfrak{R}^m$ are independent random processes with means $\bar{\mathbf{w}}$ and $\bar{\mathbf{v}}$ and covariances Q and R , respectively. The initial state is assumed to have mean $\bar{\mathbf{x}}_0$ and covariance \bar{P}_0 , and it is independent from \mathbf{w} and \mathbf{v} .

During the normal operation, the system matrices are represented by $\{F, G_0, H\}$. Once an actuator fault occurs, the matrix G becomes $G_j, j \in \{1, \dots, l\}$, at an unknown time instant k_F with an unknown change in G_0 .

The discrete version of the reference models given in (1) and (2) can be described by:

$$\begin{aligned}\mathbf{x}_j^m(k + 1) &= F_j^m \mathbf{x}_j^m(k) + G_j^m \mathbf{r}'_j(k) \\ \mathbf{y}_j^m(k) &= H_j^m \mathbf{x}_j^m(k), \quad j \in \{0, \dots, l\}\end{aligned}\quad (5)$$

Based on the system representation (4), and the desired reference model (the case with $j = 0$ in

(5)), one needs to synthesize the following control gains $\{K_0^{\mathbf{x}}, K_0^{\mathbf{x}^m}, K_0^{\mathbf{r}'}\}$ for generating the desired control signals under the normal system operation:

$$\mathbf{u}_0(k) = \underbrace{-K_0^{\mathbf{x}}\mathbf{x}_0(k)}_{\text{feedback}} + \underbrace{K_0^{\mathbf{x}^m}\mathbf{x}_0^m(k)}_{\text{reference model}} + \underbrace{K_0^{\mathbf{r}'}\mathbf{r}'_0(k)}_{\text{feedforward}} \quad (6)$$

Once a fault is detected, a new set of controller gains $\{K_j^{\mathbf{x}}, K_j^{\mathbf{x}^m}, K_j^{\mathbf{r}'}, j \in \{1, \dots, l\}\}$ will be synthesized based on the corresponding performance reduced reference model in (5) so that the post-fault system follows the degraded reference model with the new control signal generated by:

$$\mathbf{u}_j(k) = -K_j^{\mathbf{x}}\mathbf{x}_j(k) + K_j^{\mathbf{x}^m}\mathbf{x}_j^m(k) + K_j^{\mathbf{r}'}\mathbf{r}'_j(k) \quad (7)$$

where the control gains associated with reference model and command input are calculated by $K_j^{\mathbf{x}^m} = S_j^{21} + K_j^{\mathbf{x}}S_j^{11}$ and $K_j^{\mathbf{r}'} = S_j^{22} + K_j^{\mathbf{x}}S_j^{12}$, and they are functions of the feedback control gain $K_j^{\mathbf{x}}$, $j \in \{1, \dots, l\}$. The constant gain matrices S_j^{mn} , $m, n = 1, 2$; $j \in \{1, \dots, l\}$, are calculated by

$$S_j^{11} = \Phi_j^{11}S_j^{11}(F_j^m - I) + \Phi_j^{12}H_j^m \quad (8)$$

$$S_j^{12} = \Phi_j^{11}S_j^{11}G_j^m \quad (9)$$

$$S_j^{21} = \Phi_j^{21}S_j^{11}(F_j^m - I) + \Phi_j^{22}H_j^m \quad (10)$$

$$S_j^{22} = \Phi_j^{21}S_j^{11}G_j^m \quad (11)$$

and the gain matrices Φ_j^{mn} , $m, n = 1, 2$; $j \in \{1, \dots, l\}$, are determined by

$$\Phi_j = \begin{bmatrix} \Phi_j^{11} & \Phi_j^{12} \\ \Phi_j^{21} & \Phi_j^{22} \end{bmatrix} = \begin{bmatrix} F - I & \hat{G}_j \\ H^y & 0 \end{bmatrix}^{-1} \quad (12)$$

where I is an identity matrix, and \hat{G}_j is an estimate of G_j , provided by the on-line FDD scheme.

It should be pointed out that even though multiple reference models have been specified for the above reconfigurable controller design, only one set of controller as specified in (7) needs to be carried out for a particular actuator fault identified by the FDD scheme.

6. AN ILLUSTRATIVE EXAMPLE

6.1 Aircraft Model

The linearized aircraft model can be described as (Zhang and Jiang, 2003b):

$$\begin{aligned} \dot{\mathbf{x}}(t) &= \mathbf{A}\mathbf{x}(t) + \mathbf{B}\mathbf{u}(t) \\ \mathbf{y}(t) &= \mathbf{C}^y\mathbf{x}(t) \end{aligned} \quad (13)$$

where the state and the input vectors are $\mathbf{x} = [p \ r \ \beta \ \phi]^T$ and $\mathbf{u} = [\delta_a \ \delta_r]^T$, respectively, with p representing the roll rate, r the yaw rate, β the sideslip angle, ϕ the bank angle, δ_a the aileron deflection, and δ_r the rudder deflection.

6.2 Reference Models and Command Inputs Design

Since there are two control inputs which associate with two actuators in the system, two performance

degraded reference models and two set of new command inputs need to be determined.

Following the design guidelines and procedures outlined in Section 3, the parameters of the system, the desired and the degraded reference models are given in Table 1.

Table 1. The System and Reference Models

	A	B
Open-loop System	$\begin{bmatrix} -3.598 & 0.197 & -35.18 & 0 \\ -0.038 & -0.358 & 5.884 & 0 \\ 0.069 & -0.996 & -0.216 & 0.073 \\ 0.995 & 0.103 & 0 & 0 \end{bmatrix}$	$\begin{bmatrix} 14.65 & 6.538 \\ 0.218 & -3.087 \\ -0.005 & 0.052 \\ 0 & 0 \end{bmatrix}$
Desired RM	$\begin{bmatrix} -10.0 & 0 & -10.0 & 0 \\ 0 & -0.7 & 4.5 & 0 \\ 0 & -0.5 & -0.7 & 0 \\ 1 & 0 & 0 & -0.5 \end{bmatrix}$	$\begin{bmatrix} 10.0 & 5.0 \\ -5.48 & 0 \\ 0 & 0 \\ 0 & 0 \end{bmatrix}$
Degraded RM #1	$\begin{bmatrix} -5.0 & 0 & -5.0 & 0 \\ 0 & -0.117 & 0.75 & 0 \\ 0 & -0.167 & -0.233 & 0 \\ 0.333 & 0 & 0 & -0.167 \end{bmatrix}$	$\begin{bmatrix} 5.0 & 2.5 \\ -0.913 & 0 \\ 0 & 0 \\ 0 & 0 \end{bmatrix}$
Degraded RM #2	$\begin{bmatrix} -3.333 & 0 & -3.333 & 0 \\ 0 & -0.70 & 4.500 & 0 \\ 0 & -0.125 & -0.175 & 0 \\ 0.25 & 0 & 0 & -0.125 \end{bmatrix}$	$\begin{bmatrix} 3.333 & 1.667 \\ -5.48 & 0 \\ 0 & 0 \\ 0 & 0 \end{bmatrix}$

Furthermore, to meet the steady-state performance specifications, the levels of the command inputs are also adjusted based on a command governor technique. In this example, the desired command inputs under different fault conditions are given in Table 2.

Table 2 Commands for Normal/Fault Conditions

Setpoints	Normal	Aileron faults	Rudder faults
Sideslip angle	3.0	0.3	0.6
Bank angle	8.0	4.0	1.0

6.3 Simulation Results and Performance Evaluation

To evaluate performance of the proposed method, a loss of 75% of the control effectiveness in the aileron or rudder channel is simulated at time $t_F = 8$ sec. Prior to the occurrence of a fault, a constant input vector, $\mathbf{r} = [3 \ 8]^T$, is used as the original command input to represent the desired sideslip and bank angle. Once an actuator fault has been detected, the command input will be switched to the new values specified in Table 2 corresponding to the identified actuator fault.

System performance under the aileron fault. To compare the performance with and without consideration of performance degradation under the aileron fault, the closed-loop system responses of the two cases are shown in Fig. 2. The corresponding control signals are illustrated in Fig. 3. To illustrate the effect of pre-filter and how the command inputs react to faults, the corresponding command inputs are overlaid on the same graph in Fig. 3.

It can be seen that satisfactory output responses have been obtained with the specified degraded performance. Correspondingly, significantly reduced control demands at the steady-state in both con-

control channels have been required for the aircraft to track degraded reference trajectories. However, if performance degradation had not been considered, meaning that the desired reference model and the original command inputs have been used for control reconfiguration, the reconfigured output responses would track neither the original fault-free system output responses nor the expected reference trajectories with the degraded performance. This is because considerably larger control effort in the aileron channel would have been needed. In fact, the required control signal has exceeded the actuator saturation limit immediately after the fault occurrence, as shown in Fig. 3.

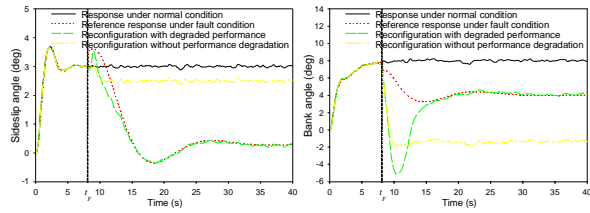

Fig. 2. System outputs with/without degradation

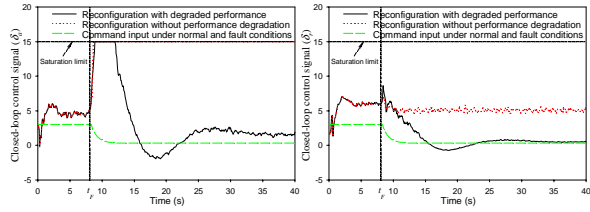

Fig. 3. Control signals with/without degradation

System performance under the rudder fault. The behavior of the system in the presence of the rudder fault has been shown in Figs. 4 and 5. Similar conclusion can be drawn as in the aileron fault case.

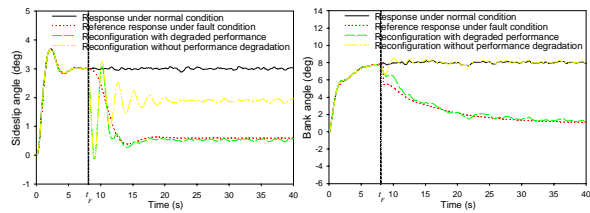

Fig. 4. Outputs using degraded/desired reference models

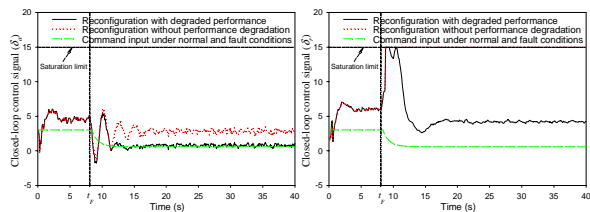

Fig. 5. Control signals using degraded/desired reference models

Further analysis. To demonstrate the role of degraded reference model, Figs. 6 and 7 show the out-

put responses and corresponding control signals using either degraded or desired reference model for control reconfiguration in the event of the 75% aileron actuator fault. It can be seen that if the same reference model used for normal condition had been used in the case of the actuator fault, faster output responses had been obtained. However, such a performance had been achieved by requiring faster rate of control signals as shown in Fig. 7, which may lead to actuator slew-rate saturation. It can also be observed from Figs. 6 and 7, with the use of either desired or degraded reference model, difference in the system responses for the two cases lies mainly on transient interval after the fault occurrence. This fact demonstrates clearly the role of the degraded reference model in governing dynamic performance of the post-fault system.

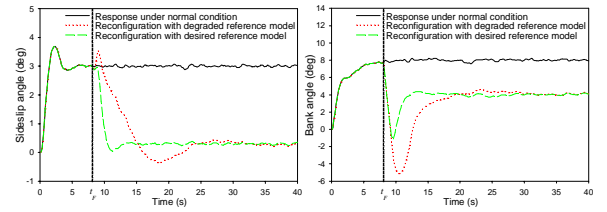

Fig. 6. System outputs using desired and degraded models

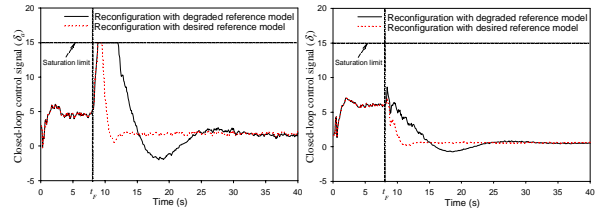

Fig. 7. Control signals using desired and degraded models

To test the performance of the developed FTCS for handling different levels of fault severity, different levels—ranging from 0% to 100% control effectiveness loss—of faults for each actuator as well as simultaneous actuator faults have been analyzed. Due to space limit, results for the following three fault levels, 75%, 50% and 25% loss of the aileron control effectiveness, are shown in Figs. 8-9. As can be seen, the performance of the reconfigured system improves as the severity of the fault decreases. Because of significant changes of the system dynamics induced by the 75% aileron fault, significantly large control signals are needed at the initial period of the system reconfiguration. In fact, the required control signal in the aileron channel has exceeded the saturation limit even before control reconfiguration has been activated. After the control reconfiguration has been implemented through command input re-adjustment together with the reconfigured controller synthesized based on the performance reduced reference model, the control signals finally settle down even to the smaller magnitude levels than that under normal condition.

Once less severe fault is introduced, the control signals during reconfiguration process are well within the limits.

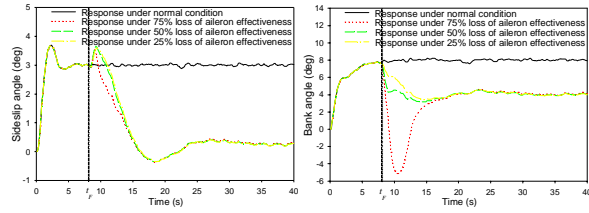

Fig. 8. System outputs under different levels of fault

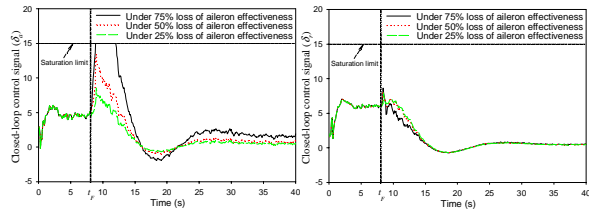

Fig. 9. Control signals under different levels of fault

To demonstrate the effects and limitations induced by actuator saturation, system responses and associated control signals without and with actuator saturation constraints are plotted further in Figs. 10 and 11. It is interesting to note that without consideration of performance degradation and actuator saturation constraints, ideally, one is able to recover the original performance in certain level. However, the price to pay for the demanded performance is that significantly large control signals need to be generated, as can be seen in Fig. 11, the required control signal in the aileron channel has exceeded the actuator saturation limit of 15 deg during the entire post-fault interval in the case of the 75% aileron fault condition. With the saturation limits on the actuators, much worse output responses can be observed, although the system is still stabilized.

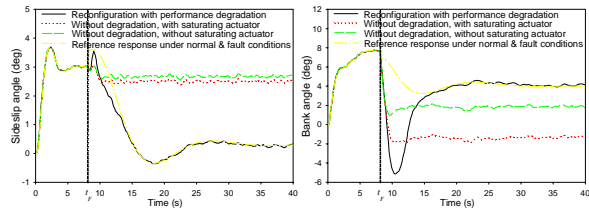

Fig. 10. Effect of actuator saturation on outputs

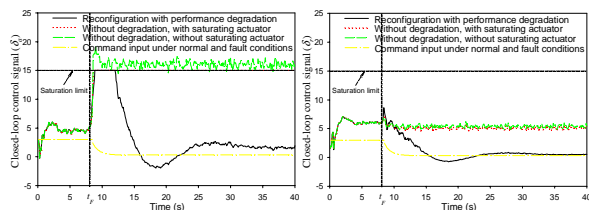

Fig. 11. Effect of actuator saturation on control signals

7. CONCLUSIONS

To achieve gracefully degraded performance under different fault conditions, a novel fault tolerant control system design method, which can deal with different actuator faults through different performance reduced reference models, has been developed and analyzed. The FTCS is designed through a model reference control structure by using a performance reduced reference model associated with each particular actuator under different levels of fault severity. Furthermore, the control system command inputs are also adjusted accordingly to avoid potential saturation. Simulation results have demonstrated the effectiveness of the proposed scheme using an aircraft example.

REFERENCES

- Blanke, M., M. Kinnaert, J. Lunze, M. Staroswiecki (2003). *Diagnosis and Fault-Tolerant Control*. Springer, Berlin, Germany.
- Chen, J. and R. H. Middleton (2003). Special issue on new developments and applications in performance limitation of feedback control. *IEEE Trans. on Automatic Control*, **48**, 1297–1398.
- Goodwin, G. C., S. F. Graebe, and M. E. Salgado (2001). *Control System Design*. Prentice Hall, Upper Saddle River, NJ, USA.
- Mahmoud, M., J. Jiang, and Y. M. Zhang (2003). *Active Fault Tolerant Control Systems: Stochastic Analysis and Synthesis*. Lecture Notes in Control and Information Sciences, Vol. 287, Springer, Berlin, Germany.
- Patton, R. J. (1997). Fault-tolerant control: the 1997 situation. *Proc. of the 3rd IFAC Symp. on Fault Detection, Supervision and Safety for Technical Processes*, 1033–1055, Hull, UK.
- Perez, T., G. C. Goodwin, and M. M. Seron (2003). Performance degradation in feedback control due to constraints. *IEEE Trans. on Automatic Control*, **48**, 1381–1385.
- Zhang, Y. M. and J. Jiang (2002). An active fault-tolerant control system against partial actuator failures. *IEE Proceedings - Control Theory and Applications*, **149**, 95–104.
- Zhang, Y. M. and J. Jiang (2003a). Bibliographical review on reconfigurable fault-tolerant control systems. *Proc. of the 5th IFAC Symp. on Fault Detection, Supervision and Safety for Technical Processes*, 265–276, Washington, D.C., USA.
- Zhang, Y. M. and J. Jiang (2003b). Fault tolerant control system design with explicit consideration of performance degradation. *IEEE Trans. on Aerospace and Electronic Systems*, **39**, 838–848.