

# A real-time optimization control strategy for power management in fuel cell/battery hybrid power sources

Chun-Yan Li  
Institute of Automation  
Chinese Academy of Sciences  
Beijing, China  
Email: lichunyan820@126.com

Geng Zheng  
Institute of Automation  
Chinese Academy of Sciences  
Beijing, China  
Email: geng.zheng@ia.ac.cn

Guo-Ping Liu  
Faculty of Advanced Technology  
University of Glamorgan  
Pontypridd, Wales, UK  
Email: gpliu@glam.ac.uk

**Abstract**—The power management strategy can greatly affect the fuel economy of hybrid power systems. This work presents an optimization based power management strategy of hybrid fuel cell power sources during real-time operation. In this approach, local optimization strategy is adopted because it doesn't need the priori knowledge of the future power demand. Every step, the current power demand is measured and the real-time optimal power distribution is determined by maximizing the efficiency of the hybrid system. Simulation and experimental results are presented to show that this real-time power management optimization strategy is feasible and can provide good fuel economy.

**Keywords**—Fuel cell hybrid, Power management, Real-time optimization

## I. INTRODUCTION

Fuel cell is considered as one of the most attractive power sources with applications ranging from automobiles to stand alone power generation plants due to its environmental-friendly [1], [2]. Among the various kinds of fuel cells, proton exchange membrane fuel cells is one of the promising energy sources due its higher power density, lower operation temperature, quick start up and long cycle life [3]–[5]. However, the dynamics of the fuel cell stack is limited by the air and hydrogen delivery system. A fuel cell only power system may not be sufficient to meet the load demands, especially in peak power demand or transient situation. Other energy storage devices, such as batteries and supercapacitors, are needed to supplement the fuel cell system in application [6]–[8].

In research of the fuel cell hybrid power sources, study of the power management strategy is one of the important tasks, especially in fuel cell hybrid vehicles. Many literatures about power management control strategy, based on optimization, can be found. Brahma et al. [9] used the dynamic programming technique in the optimization of instantaneous generation/storage power split in series hybrid electric vehicles. Delprat et al. [10] presented a global optimization method based on optimal control theory. All of these optimized power management strategies are based on a prior knowledge of the future power demand and not suitable for real time control.

Also, Some literatures studied the real time power management strategies, based on real time optimization. Delprat et al.

[11] derived a real-time control strategy from optimal control theory. Rodatz et al. [13] also used ECMS to determine the real time optimal power distribution of a fuel cell/supercapacitor hybrid vehicle.

In general, it is need a priori knowledge of the future power demand to find a global optimal solution of power management. So, global optimization is infeasible in real time power management control. On the other hand, strategies that deal with local optimization are suitable to real implementation. In this paper, a fuel cell/battery hybrid power source is studied and a local optimal power management strategy is presented. The performance of this local optimal solution is compared with that of a optimal fuzzy power control and management strategy that presented in literature [14].

The organization of this paper is as follows. In section II, the structure, characteristics and models of hybrid power sources are introduced. Then, the proposed power management strategy based on local optimization is presented in section III. In section IV, the simulation results are shown and the performance of the proposed strategy is compared with that of other strategies. The experimental results are also reported in this section. Finally, the conclusions of this paper are included in section V.

## II. HYBRID POWER SOURCES

The fuel cell/battery hybrid power sources combine the high power density of batteries with high energy density of fuel cells. The fuel cell hybrid power sources consist of the fuel cell stack, a battery bank, the DC/DC converter to stable the fuel cell output voltage.

Fig. 1 is represented the proposed topology of the fuel cell hybrid power system. The fuel cell system is connected to the DC bus with a DC/DC converter, whereas the battery bank is directly connected to DC bus passively. As to the load, a AC motor is considered. The current flow to the DC bus from fuel cell system can be controlled by the DC/DC converter, the difference between the current draw from the inverter and the current out from DC/DC converter is compensated by the battery bank. Given a certain load power  $P_{load}$ , this power

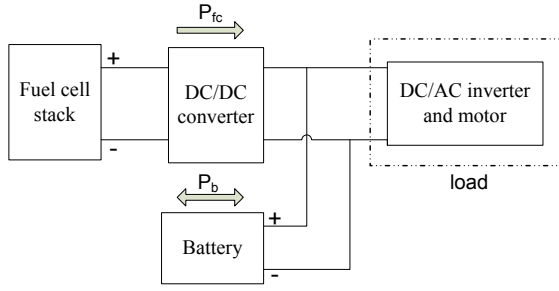

Fig. 1. configuration of fuel cell hybrid power sources

should be supplied by fuel cell system,  $P_{fc}$  and the battery bank,  $P_b$ . At every time, the power balance should be satisfied. That is

$$P_{fc}(t_k)\eta_{dc} + P_b(t_k)\eta_b = P_{load}(t_k) \quad \forall t_k \quad (1)$$

where  $\eta_{dc}$  and  $\eta_b$  are the efficiency of DC/DC converter and the efficiency of battery bank respectively. Here, we assume that the DC/DC converter is well controlled and the efficiency is known.

The main objective of the power management strategy is to reduce the hydrogen consumption and improve the efficiency of hybrid power system. For a given fuel cell system, the hydrogen consumption along with the output power of fuel cell system is a matter of much concern. So, here, we developed a static fuel cell model. It is assumed that the temperature of the fuel cell system is well maintained at the operating condition (around 65°C) and the pressure difference between the cathode and the anode is ignored. A typical efficiency characteristic of a fuel cell system with a 50-kW rate power is shown in Fig. 2.

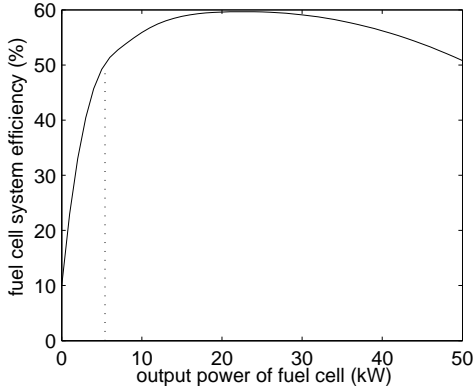

Fig. 2. ADVISOR efficiency map for a 50-kW fuel cell system as a function of output power

The battery pack consists of serially connected battery cells. The internal resistance is the major factor to limit charging and discharging capability. The internal resistance model is used in this study. This model is related to work which was originally performed by Idaho National Engineering Laboratory to model flooded lead-acid batteries [15]. A battery cell is modelled

with a voltage source and an internal resistor with temperature ignored (Fig. 3). The resistance and open circuit voltage both are the nonlinear functions of battery state of charge (SOC) (Fig. 4). These relationships are implemented as look-up tables with test data. This simple battery model enables fast calculation for optimization and makes it possible to apply the real time optimization power management strategy.

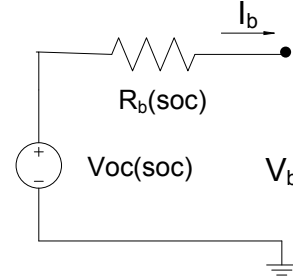

Fig. 3. Internal resistance battery model.

As shown in Fig. 3, the terminal voltage of battery pack  $V_b$  can be written by

$$V_b = n_b(V_{oc} - R_b I_b) \quad (2)$$

where  $n_b$  is the number of battery cells,  $V_{oc}$  is the open circuit voltage of the battery cell,  $R_b$  is the internal resistance and  $I_b$  is the current flow out the battery.  $I_b$  can be calculated by

$$I_b = \frac{V_{oc} - \sqrt{(V_{oc}^2 - \frac{4R_b P_b}{n_b})}}{2R_b} \quad (3)$$

The SOC of battery is denoted by

$$SOC(k) = SOC_0 - \frac{1}{C_b} \int_{t_0}^{t_k} I_b dt \quad (4)$$

where  $k$  is the time step and  $C_b$  is the capacity of battery cell.

When the battery pack is discharging, the discharge efficiency of the battery pack can be written as

$$\eta_{dis} = \frac{V_b I_b}{V_{oc} I_b} = \frac{1}{2} + \frac{1}{2} \sqrt{1 - \frac{4R_{dis} P_b}{V_{oc}^2}} \quad (5)$$

where  $R_{dis}$  is the discharge resistance of battery cell.

Similarly, for the battery charge process, the charge efficiency is given by

$$\eta_{chg} = \left( \frac{1}{2} + \frac{1}{2} \sqrt{1 - \frac{4R_{chg} P_b}{V_{oc}^2}} \right)^{-1} \quad (6)$$

where  $R_{chg}$  is the charge resistance of the battery cell.

### III. POWER MANAGEMENT STRATEGY OF THE HYBRID POWER SOURCES

In this section, a power management strategy based on real time optimization is addressed. The main objective of power management strategy is to improve the efficiency of the hybrid system while maintaining the SOC of the battery pack in a certain range.

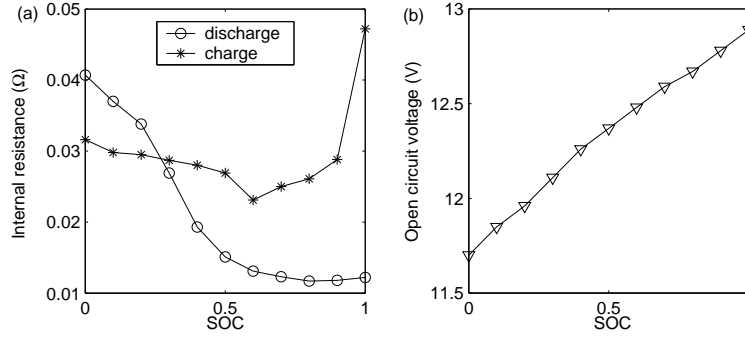

Fig. 4. The relationship between (a) internal resistance and SOC, and (b) open circuit voltage and SOC in ADVISOR.

### A. The concept of equivalent fuel consumption

Ideally, The overall efficiency of the hybrid system is defined by

$$\eta_{sys} = \frac{\sum_0^{t_f} P_{load}(t_k) \Delta t_k}{E_{fc} + \sum_0^{t_f} \lambda_{pb}(t_k) P_b(t_k) \Delta t_k} \quad (7)$$

where  $\eta_{sys}$  is the overall efficiency of the hybrid system,  $P_{load}(t_k)$  is the power supplied in to the vehicle at time step  $\Delta t$ ,  $E_{fc}$  is the energy of hydrogen fuel supplied into the fuel cell stack,  $P_b(t_k)$  is the battery power of charge or discharge at time step  $\Delta t$ ,  $\lambda_{pb}(t_k)$  is the equivalence factor which can be evaluated by the concept of equivalent consumption at time step  $\Delta t$ .

The energy of hydrogen fuel supplied to the fuel cell during the given mission is calculated according to

$$E_{fc} = \sum_0^{t_f} \frac{P_{fc}(t_k)}{\eta_{fc}(t_k)} \Delta t \quad (8)$$

where  $\eta_{fc}(t_k)$  is the efficiency of the fuel cell system at time step  $\Delta t_k$  when the output power is  $P_{fc}(t_k)$ . It can be obtained from the efficiency map of the fuel cell system shown in Fig. 2.

To make the electrical energy consumption of the battery and fuel energy of hydrogen comparable, the electrical energy consumption of the battery is converted into equivalent fuel consumption. Paganelli et al. [16] proposed the concept of equivalent fuel consumption. The concept is that if the battery discharged some power  $P_b(t_k)$  at time step  $\Delta t$ , to maintain the SOC, the battery will be recharged using the energy of the fuel cell in the future. The discharge efficiency can be written as

$$\eta_{dis}(t_k) = \frac{1}{2} + \frac{1}{2} \sqrt{1 - \frac{4R_{dis}(t_k)P_b(t_k)}{V_{oc}(t_k)^2}} \quad (9)$$

where  $R_{dis}$  is the discharge resistance of battery.

Similarly, for the battery charge process, the charge efficiency is given by

$$\eta_{chg}(t_k) = \left( \frac{1}{2} + \frac{1}{2} \sqrt{1 - \frac{4R_{chg}(t_k)P_b(t_k)}{V_{oc}(t_k)^2}} \right)^{-1} \quad (10)$$

The battery equivalent fuel consumption is defined as

$$C_b(t_k) = \lambda_{cb}(t_k) P_b(t_k)$$

$$\lambda_{cb}(t_k) = \begin{cases} \frac{C_{fc,avg}}{P_{fc,avg} \eta_{dis}(t_k) \eta_{chg,avg}} P_b(t_k) \geq 0 \\ \frac{C_{fc,avg} \eta_{chg}(t_k) \eta_{dis,avg}}{P_{fc,avg}} P_b(t_k) < 0 \end{cases} \quad (11)$$

Because the future operating points are not known, the average charge efficiency of the battery is used and also, the average fuel cell power and its fuel consumption are used.

According to (11), the equivalence factor  $\lambda_{pb}(t_k)$  can be calculate by

$$\lambda_{pb}(t_k) = \frac{P_{fc,avg}}{\eta_{fc} C_{fc,avg}} \lambda_{cb}(t_k) \quad (12)$$

### B. Optimization problem statement

The problem is to solve this global optimization problem, the load power demand in the given mission has to be known a priori. But in many cases, we can not get this power demand until it is generated by the load, especially in automotive applications. So instead of the global optimization, we reduce the global optimization to a local one. That is, for each time  $t_k$  with a time step  $\Delta t_k$ , we solve the local optimization problem by maximizing the objective  $J(t_k)$ , defined as

$$J(t_k) = \frac{P_{load}(t_k) \Delta t_k}{\left( \frac{P_{fc}(t_k)}{\eta_{fc}(t_k)} + \lambda_{pb}(t_k) P_b(t_k) \right) \Delta t_k} \quad (13)$$

The global optimization is not equal to the local problem described above. But it can be easily used for real time control whereas its global counterpart is non-causal and non-realizable [12].

For all  $t_k$  the constraints in the fuel cell power and the battery pack power are

$$\begin{aligned} 0 &\leq P_{fc}(t_k) \leq P_{fc,max} \\ \Delta P_{fc,fallrate} &\leq \frac{\Delta P_{fc}(t_k)}{\Delta t_k} \leq \Delta P_{fc,riseate} \\ P_{b,chg,max} &\leq P_b(t_k) \leq P_{b,dischg,max} \\ SOC_{min} &\leq SOC(t_k) \leq SOC_{max} \end{aligned} \quad (14)$$

where  $P_{fc,max}$  is the maximum power that fuel cell system can deliver,  $\Delta P_{fc,fallrate}$  and  $\Delta P_{fc,rise rate}$  are maximum fall rate of  $P_{fc}$  and maximum rise rate of  $P_{fc}$  respectively. With regard to the battery pack, the maximum power flows are also limited. The maximum power that the battery pack can deliver  $P_{b,dischg,max}$  or store  $P_{b,chg,max}$  depends on the actual voltage of the battery pack  $V_{oc}$ , the maximum voltage  $V_{b,max}$ , and the minimum voltage  $V_{b,min}$  [17].

$$P_{b,chg,max} = \frac{n_b V_{oc} (V_{oc} - V_{b,max})}{R_d} \quad (15)$$

$$P_{b,dischg,max} = \frac{n_b V_{oc} (V_{oc} - V_{b,min})}{R_d} \quad (16)$$

Because  $V_{oc}$  and  $R_d$  both are depend on the SOC of the battery pack, whereas the SOC is various in the duration of the given mission. The values of  $P_{b,chg,max}$  and  $P_{b,dischg,max}$  are various at each time step in optimization.

To get the optimal power distribution, the local optimization problem that should be solved at each time  $t_k$  with a time step  $\Delta t_k$  is

$$\begin{aligned} \text{Maximize } J(t_k) &= \frac{P_{load}(t_k) \Delta t_k}{\left(\frac{P_{fc}(t_k)}{\eta_{fc}(t_k)} + \lambda_{pb}(t_k) P_b(t_k)\right) \Delta t_k} \\ \text{s.t. } P_{fc}(t_k) \eta_{dc} + P_b(t_k) \eta_b &= P_{load}(t_k) \\ 0 &\leq P_{fc}(t_k) \leq P_{fc,max} \\ \Delta P_{fc,fallrate} &\leq \frac{\Delta P_{fc}(t_k)}{\Delta t_k} \leq \Delta P_{fc,rise rate} \\ P_{b,chg,max}(t_k) &\leq P_b(t_k) \leq P_{b,dischg,max}(t_k) \\ SOC_{min} &\leq SOC(t_k) \leq SOC_{max} \end{aligned} \quad (17)$$

To avoid the "starvation" of reactants in the fuel cell system and take the slow dynamics into account, the output power of fuel cell system is increased no faster than a certain power rise rate  $\Delta P_{fc,rise rate}$ . Also, the power fall rate of the fuel cell system is restricted to prevent overpressure into the stack.  $SOC_{max}$  is the upper bound of SOC and  $SOC_{min}$  is the lower bound of SOC. As a conservative target, 0.8 and 0.4 are used in this study.

### C. Implementation and practical considerations

The fuel cell system has several subsystems such as the gas supply subsystem, the humidifying subsystem, the temperature control subsystem and so on. The anode pressure, cathode pressure, the temperature and the moisture should be appropriately controlled. All these control algorithms are achieved through a so-called NetController, which has been developed by CASIA. To reduce the calculation work of NetController, the real time optimization problem is solved in MATLAB, which can also take advantage of MATLAB optimization toolbox. User Datagram Protocol (UDP) communication is adopted to exchange the necessary data between the NetController and MATLAB. The proposed real time optimization power management strategy here is shown in Fig. 5.

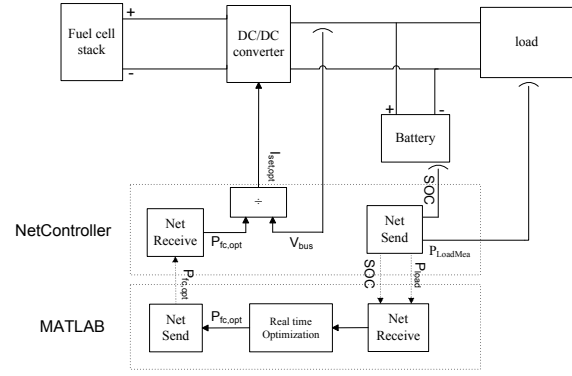

Fig. 5. Proposed power management strategy based on real time optimization

At each time  $t_k$  with a time step  $\Delta t_k$ , the following steps are performed in real time optimization process:

- The load power and the battery SOC are measured by the sensor connected with NetController, and then, these values are sent to MATLAB by UDP communication program.
- MATLAB receives the values of load power and battery SOC, solve the optimization problem shown by 17) and get the optimal set point of fuel cell power  $P_{fc,opt}(t_k)$  and the optimal value of  $J(t_k)$ .
- MATLAB sends the optimal value  $P_{fc,opt}(t_k)$  to the NetController.
- The Netcontroller receives the value of  $P_{fc,opt}(t_k)$ , calculate the set point current of the DC/DC converter.

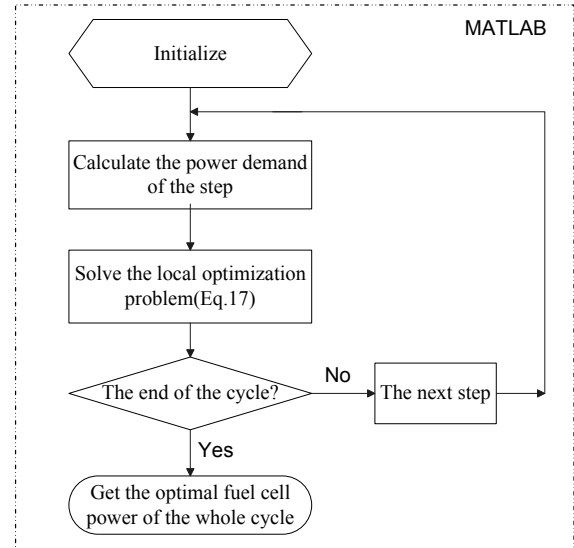

Fig. 6. The simulation flowchart of the proposed power management strategy

## IV. OPTIMIZATION AND EXPERIMENTAL RESULTS

The proposed power management strategy based real time optimization are tested by simulation and experiments. Section

A is devoted to simulation results and analysis. The implementation of the proposed strategy in an experimental test setup is presented in section B.

### A. Simulation results

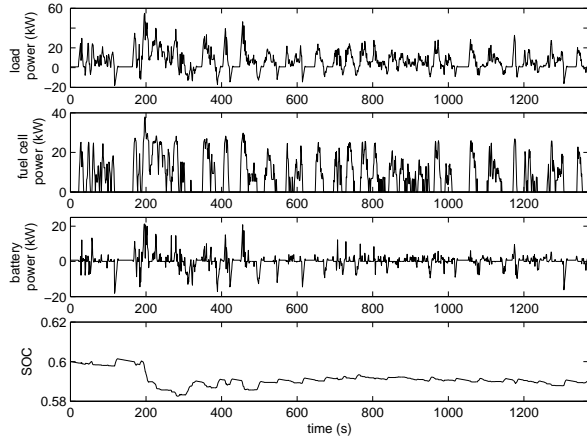

Fig. 7. The simulation results of the proposed strategy for UDSS cycle.

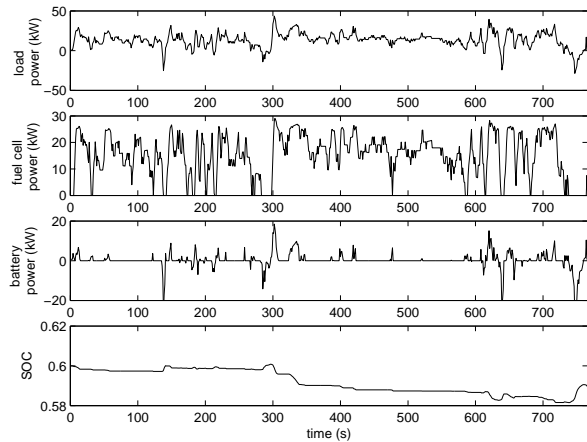

Fig. 8. The simulation results of the proposed strategy for HWFET cycle.

To compare the performance of the proposed real time optimization strategy with other power management strategies especially the global optimization control strategy, we simulated the power demand of a typical vehicle in three driving cycles: UDSS, HWFET, and NEDC. The optimization results of the proposed power management strategy and the optimal fuzzy power management strategy described in literature [14] are shown in Table I. In this table, the degree of hybridization (DOH) is defined as the ratio of electric power can be delivered by the energy storage system (here it means the battery pack) to the total power that can be delivered by ESS and fuel cell system [18]. The simulation is carried out in MATLAB, process of the simulation is shown in Fig. 6.

Fig. 7 shows the simulation results with the real time optimization power management strategy for UDSS cycle.

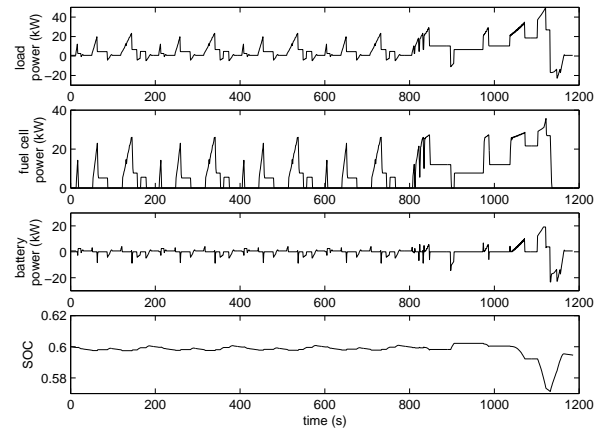

Fig. 9. The simulation results of the proposed strategy for NEDC cycle.

The simulation results for HWFET cycle and NEDC cycle are shown in Fig. 8 and Fig. 9.

Optimization results in Table I show that the hydrogen economy of the real time optimization power management strategy is not as good as that of the global optimization. That is reasonable because the global optimization strategy is based on power demand of the entire driving cycle which is infeasible in practice, whereas the real time optimization is just based on the present power need.

### B. Experimental validation

In this subsection, the experimental results are presented to validate the feasibility and practicability of the proposed real time optimization power management strategy.

The experimental setup is composed of a PEM fuel cell test rig, a lead-acid battery pack, a constant-voltage restricted-current DC/DC converter and car lights to emulate the power consumption. The PEM fuel cell test rig are designed and built by Institute of Automation, Chinese Academy of Sciences(CASIA). 24 cells are connected in series to make up the fuel cell stack. The voltage level can vary from 22V at no load to about 16V at full load. The rated power of this small fuel cell system is 150W and The max rise rate of the fuel cell is 30W/s. The DC/DC converter is connected after the fuel cell system to stable the output voltage and control the fuel cell output power. A 24 AH,12V lead acid is connected to dc bus. Car lights are used as the power load.

The optimization process is executed at every second and the experimental results are shown in Fig. 10. The results show that when the load power demand is the range that the fuel cell and battery can afford, the fuel cell system is apt to work at the power range that the system has the maximum efficiency.

## V. CONCLUSIONS

In this work, a new power management strategy based on real time optimization for fuel cell hybrid power sources system was addressed. Compared to the global optimization strategies that need the power demand of the entire task, which is not feasible in practice, the proposed strategy only

TABLE I  
OPTIMIZATION RESULTS COMPARISON OF THE LOCAL OPTIMIZATION STRATEGY AND THE GLOBAL OPTIMIZATION STRATEGY

Simulation outputs	Units	UDDS cycle		HWFET cycle		NEDC cycle	
		local	global	local	global	local	global
		optimization strategy <sup>a</sup>	optimization strategy	optimization strategy <sup>a</sup>	optimization strategy	optimization strategy <sup>a</sup>	optimization strategy
Total fuel consumption( $H_2$ ) <sup>b</sup>	g	145.7	142.6	163.6	154.5	125.9	123.1
$\Delta SOC$		-0.0103	0.0249	-0.0103	0.0299	-0.0093	0.0058
Cycle length	km	11.99	11.99	16.51	16.51	10.94	10.94
Specific energy consumption <sup>c</sup>	$MJkm^{-1}$	1.48	1.39	1.21	1.09	1.37	1.33

<sup>a</sup> Fixed DOH=0.3786.

<sup>b</sup> We use the lowest energy content of hydrogen,  $120MJkg^{-1}$ .

<sup>c</sup> The energy that the battery pack delivered or stored during the driving cycles is transformed to the hydrogen consumption by the concept of equivalent fuel consumption.

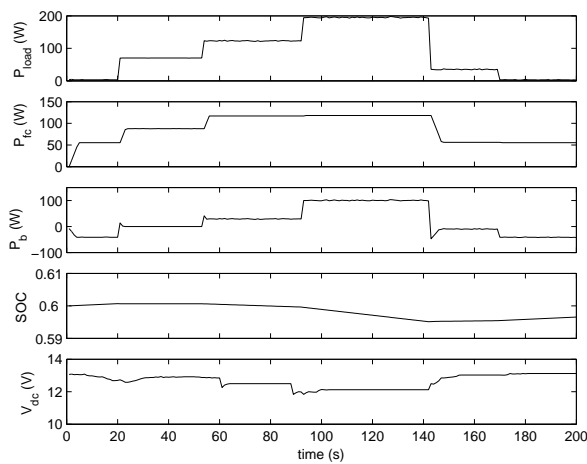

Fig. 10. Experimental results of the power management strategy based on real time optimization.

need the current power demand and can be easily applied in practice. The proposed strategy was tested both in simulation environment using three standard driving cycles and in an experiment. Compared to other power management strategies, the followings are verified: First, although the hydrogen economy of power management strategy based on real time optimization is not as good as the strategy based on global optimization, the proposed strategy still has a comparative good fuel economy. Second, if the power demand is near constant and the power demand deceleration is low, the fuel economy improved by optimization, no matter local optimization or global optimization, is insignificant. Finally, the experimental test shows that the proposed strategy is very easy to be implemented in practice.

## REFERENCES

- [1] M. M. Hussain, I. Dincer, and X. Li, "A preliminary life cycle assessment of pem fuel cell powered automobiles," *Appl. Therm. Eng.*, vol. 27, no. 13, pp. 2294 – 2299, 2007.
- [2] L. Schlecht, "Competition and alliances in fuel cell power train development," *Int. J. Hydrogen Energy*, vol. 28, no. 7, pp. 717 – 723, 2003, market Challenges of Fuel Cell Commercialization.
- [3] P. Costamagna and S. Srinivasan, "Quantum jumps in the pemfc science and technology from the 1960s to the year 2000: Part ii. engineering, technology development and application aspects," *J. Power Sources*, vol. 102, no. 1-2, pp. 253 – 269, 2001.
- [4] D. Chu, R. Jiang, K. Gardner, R. Jacobs, J. Schmidt, T. Quakenbush, and J. Stephens, "Polymer electrolyte membrane fuel cells for communication applications," *J. Power Sources*, vol. 96, no. 1, pp. 174 – 178, 2001.
- [5] F. Barbir and T. Gomez, "Efficiency and economics of proton exchange membrane (pem) fuel cells," *Int. J. Hydrogen Energy*, vol. 22, no. 10-11, pp. 1027 – 1037, 1997.
- [6] M. Uzunoglu and M. Alam, "Dynamic modeling, design, and simulation of a combined pem fuel cell and ultracapacitor system for stand-alone residential applications," *IEEE Trans. Energy Convers.*, vol. 21, no. 3, pp. 767–775, Sept. 2006.
- [7] M. Kim, Y.-J. Sohn, W.-Y. Lee, and C.-S. Kim, "Fuzzy control based engine sizing optimization for a fuel cell/battery hybrid mini-bus," *J. Power Sources*, vol. 178, no. 2, pp. 706 – 710, 2008.
- [8] P. Thounthong, S. Rael, and B. Davat, "Analysis of supercapacitor as second source based on fuel cell power generation," *IEEE Trans. Energy Convers.*, vol. 24, no. 1, pp. 247–255, March 2009.
- [9] A. Brahma, Y. Guezennec, and G. Rizzoni, "Optimal energy management in series hybrid electric vehicles," in *Proc. 2000 American Control Conf.*, vol. 1, no. 6, pp. 60–64, Sep 2000.
- [10] S. Delprat, T. Guerra, G. Paganelli, J. Lauber, and M. Delhom, "Control strategy optimization for a hybrid parallel powertrain," in *Proc. 2001 American Control Conf.*, vol. 2, pp. 1315–1320, 2001.
- [11] S. Delprat, T. Guerra, and J. Rimaux, "Optimal control of a parallel powertrain: from global optimization to real time control strategy," *IEEE 55th Vehicular Technology Conf., 2002.*, vol. 4, pp. 2082–2088, 2002.
- [12] A. Sciarretta, M. Back, and L. Guzzella, "Optimal control of parallel hybrid electric vehicles," *IEEE Trans. Control Syst. Technol.*, vol. 12, no. 3, pp. 352–363, May 2004.
- [13] A. L. P. Rodatz, G. Paganelli, "Optimal power management of an experimental fuel cell/supercapacitor-powered hybrid vehicle," *Control Eng. Pract.*, vol. 13, no. 1, pp. 41 – 53, 2005.
- [14] C.-Y. Li and G.-P. Liu, "Optimal fuzzy power control and management of fuel cell/battery hybrid vehicles," *J. Power Sources*, vol. 192, no. 2, pp. 525 – 533, 2009.
- [15] V. H. Johnson, "Battery performance models in advisor," *J. Power Sources*, vol. 110, no. 2, pp. 321 – 329, 2002.
- [16] G. Paganelli, S. Delprat, T. Guerra, J. Rimaux, and J. Santin, "Equivalent consumption minimization strategy for parallel hybrid powertrains," *IEEE 55th Vehicular Technology Conf., 2002.*, vol. 4, pp. 2076–2081, 2002.
- [17] D. Feroldi, M. Serra, and J. Riera, "Energy management strategies based on efficiency map for fuel cell hybrid vehicles," *J. Power Sources*, vol. 190, no. 2, pp. 387 – 401, 2009.
- [18] R. K. Ahluwalia, X. Wang, and A. Rousseau, "Fuel economy of hybrid fuel-cell vehicles," *J. Power Sources*, vol. 152, pp. 233 – 244, 2005.